

WINEGARD®

METROSTAR® VHF/UHF OMNIDIRECTIONAL TV ANTENNA

AMPLIFIED MODEL MS-2000 (MS-2006 BULK), MS-2002
NON-AMPLIFIED MODEL MS-1000 (MS-1006 BULK), MS-1002

(MAST NOT INCLUDED)

Made in U.S.A.

INSTRUCTIONS

WARNING!

DANGER OF ELECTROCUTION
CHECK AREA AROUND ANTENNA SITE FOR OVERHEAD WIRES. DO NOT ALLOW ANTENNA, MAST OR GUY WIRES TO CONTACT OVERHEAD WIRES. (SEE INSTALLATION SAFETY INSTRUCTIONS.)

Many do-it-yourself and professional antenna installers are injured or killed each year by electrocution. While anyone can see the obvious danger of falling, the most resourceful sometimes fails to recognize overhead wires as being potentially lethal. To touch any part of the antenna mast or guy wires to these overhead wires is the same as touching them with your bare hand. A very serious shock is almost sure to result when contacting an electrical wire, and in the case of primary wires on the top of poles, the shock is like being struck by a bolt of lightning. Many power wires are within 20' to 25' of the ground and could easily be touched by an assembled antenna and mast.

WARNING!

TO PREVENT FIRE OR SHOCK HAZARD, DO NOT EXPOSE POWER SUPPLY SECTION OF THIS APPLIANCE TO RAIN OR MOISTURE.

Please read and follow these suggestions, if applicable:

1. Try to have two people available for help, if needed.
2. Try to select antenna site well away from all overhead wires. Check distances.
3. If possible, do all assembly work on ground and then raise the antenna.
4. Don't try to install antenna when it is windy.
5. If anything should come in contact with the overhead wires, call the power company. They will remove it safely.
6. Don't try to guess which overhead wires carry high voltage. Check with power company.
7. Make the installation secure. Use plenty of guy wires and good hardware.
8. Make sure antenna mast and downlead cable are connected to suitable lightning arrestors. Use at least No. 8 ground wire between mast and ground.
9. Do not run downlead over power wires.
10. Get professional help when removing the old antenna if there is any doubt of clearing overhead wires.

Winegard Company
3000 Kirkwood Street • Burlington, Iowa 52601-2000

DESCRIPTION

Winegard's MetroStar® antenna with fixed FM trap (88 to 108 MHz) (MS-2000/2002/2006 only) provides excellent reception of VHF/UHF TV channels for home use in most viewing locations. The MetroStar antenna's compact modern styling is unobtrusive and blends well with the decor of homes and condominiums. The UV protected housing is fabricated of impact resistant filled copolymer, making the exterior virtually impervious to weathering and color change.

The unique omnidirectional characteristics of the MetroStar antenna provide excellent reception in areas where stations are in different directions without the need for a complex rotor system. A built-in amplifier, (MS-2000/2002/2006 only), provides up to six times the received signal on VHF and nine times the UHF signal, insuring the best possible reception in color and black and white.

The MetroStar antenna is easily installed with simple hand tools on any antenna mast or optional light duty antenna mount.

PARTS LIST

MS-2000

- Amplified Antenna Head.....
- Mounting Bracket..... 3720317
- 1 Mast Clamp 3640051
- 2" U-Bolt 1160321
- 1 1-14 x 1" Nylon bolt 3200350
- 2 1/4-20 Hex Nut Flange/Serrated..... 2160228
- Power Injector.....
- 50' Coaxial Cable/Connectors/Boot..... 2753011
- 6' Coaxial Cable 2753752
- 2 #6 x 1/2" Screws..... 2160105

MS-2002

Same as MS-2000, except no 50' cable. Single pack.

MS-2006

Same as MS-2000, except no 50' cable. Packed 6 units per carton.

MS-1000 (Non-amplified)

Non-amplified version of MS-2000, no power supply and no 6' coaxial cable, single pack.

MS-1002 (Non-amplified)

Same as MS-1000, no power supply, no 50' cable, no 6' coaxial cable, single pack.

MS-1006 (Non-amplified)

Same as MS-1000, no power supply, no 6' cable. Packed 6 units per carton.

NOTE

MILEAGE REFERENCE
MS-2000 10-45 MILES
MS-1000 5-15 MILES

Amplified antennas installed within 10 miles of TV station towers, could cause overloading of the preamp. If overloading occurs, then try a non-amplified model.

DIMENSIONS

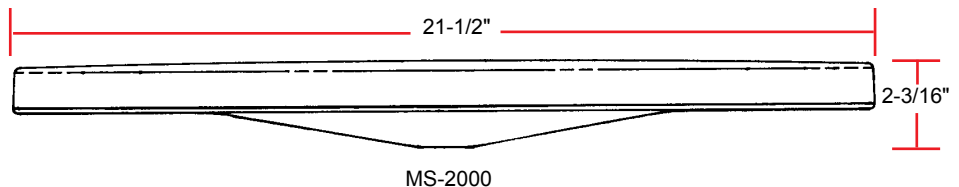

	SPECIFICATIONS (MODELS MS-2000/2002/2006)	SPECIFICATIONS (MODELS MS-1000/1002/1006)
Bandpass		
VHF	58 to 88, 170 to 216 MHz	58 to 88, 170 to 216 MHz
UHF	470 to 810 MHz	470 to 810 MHz
FM Trap (Fixed)	Attenuates 88 to 108 MHz 15 dB	N/A
Amplifier Gain		
VHF	15.5 dB average	N/A
UHF	19.5 dB average	N/A
Impedance	75 ohm unbalanced	75 ohm unbalanced
Response	.25 dB per 6 MHz	.25 dB per 6 MHz
VSWR	1.8:1 maximum	1.8:1 maximum
Power Required	117 VAC, 60 Hz, 4.3 watts	N/A
Weatherproof Housing	UV protected filled copolymer	UV protected filled copolymer
Mounting Type	Round mast up to 1-3/4" O.D.	Round mast up to 1-3/4" O.D.

ANTENNA MOUNTING INSTRUCTIONS

STEP 1: Attach mounting bracket to bottom of antenna as shown in Figure 1 and mount antenna on mast. The tab on the plastic screw and notch on the bracket ensure a secure connection. Use center set of holes on bracket. Tighten U-bolt. Connect downlead to jack on antenna, slide weather boot over boot collar.

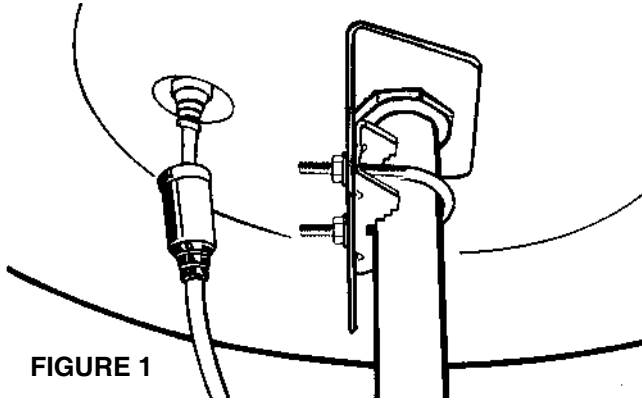

FIGURE 1

(NON-AMPLIFIED)

STEP 2. Attach downlead from antenna to TV set.

(AMPLIFIED MODELS) If using the power supply, follow these steps.

STEP2. Attach “F” connector on downlead cable to power injector jack marked “ANTENNA”. See figure 2.

STEP 3. Attach “F” connector on cable from analog TV/ DTV receivers to power injector jack marked “TV”. See figure 2.

FIGURE 2

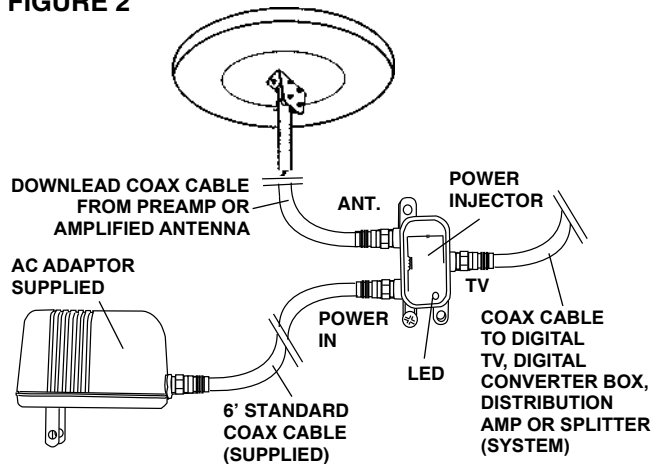

STEP 4. Connect one “F” connector on supplied black RG-6 cable to power injector jack marked “PWR IN”. Connect the other “F” connector on supplied RG-6 cable to jack on supplied AC (Wall Adaptor). See Figure 2.

STEP 5. Mount power injector to wall using supplied screws. Plug in AC wall transformer to household wall outlet.

TIPS:

If splitting the signal to multiple TVs or combining with another signal source, it is strongly recommended that the power injector be installed between the antenna and the splitter/combiner input. In this case, the cable connection from the “TV” jack of the power injector goes to the splitter input or valid combiner input. Use splitters rated from 54-806 MHz or wider bandwidth (commonly 5-1000 MHz) for over-the-air television signal distribution.

Additional distribution/inline amplifiers must be installed FOLLOWING the TV output of the power injector, NOT on the downlead cable line connecting to the ANTENNA port. Check TV picture quality, if the power injector LED is glowing when powered, and antenna alignment prior to adding additional line amplifiers.

To maximize the operating life of the amplifier, install the power injector close to the TV receiver (if only one will be used with the antenna) or the first signal split. A maximum antenna-to-power injector length of 150 feet RG-6 or 150 feet RG-59 is acceptable.

RECOMMENDATIONS FOR INSTALLING COAX CABLE

Minimum Bending Radius: (RG-59/U, RG-6/U type) 3 inch radius. Tighter bends will cause shorts and change impedance.

Pulling Tension: (Winegard CL-2700, CL-2800) 75 pounds maximum. Leave no tension on cable after it is installed.

Staples or Clamps: The use of flat staples with coax cable is damaging to the cable. Only round headed staples can be used. Any clamps or securing devices used with coax should grip the cable evenly about the circumference without crushing the cable.

Exposure to High Heat: Maximum temperature limit 80°C (176°F). Keep cable away from heating vents, water heaters.

Crushing: Coax should not be installed in a manner that would allow it to be crushed. The coax should not be stuffed or wedged into areas where the cable could be pinched.

Exposure to Moisture: Cable jacket will withstand most outdoor environments. However, connections and splices must be sealed against water entry.

TYPICAL HOME INSTALLATIONS

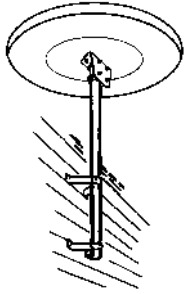

WALL MOUNT

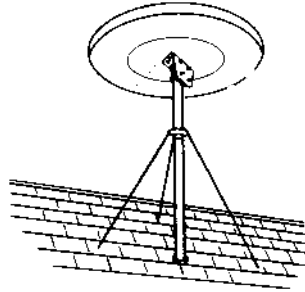

ROOF MOUNT

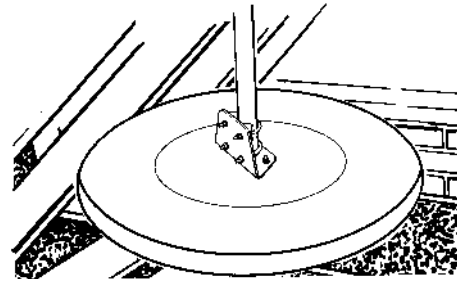

ATTIC MOUNT

HOW TO PROVIDE LIGHTNING PROTECTION FOR YOUR TV ANTENNA AND SET (For outside mount)

Mount lightning arrester as close as possible to where lead-in enters house.

Ground wires for both mast and lead-in should be copper or aluminum wire, number 8 or larger.

Lead-in wire from antenna to lightning arrester and mast ground wire should be secured to house with stand-off insulators, spaced from four to six feet apart.

In the case of a "ground up" antenna installation, it may not be necessary to ground the mast if the mast extends four or more feet into the earth. Consult your TV service man for proper depth in your area.

EXAMPLE OF ANTENNA GROUNDING AS PER NATIONAL ELECTRICAL CODE INSTRUCTIONS

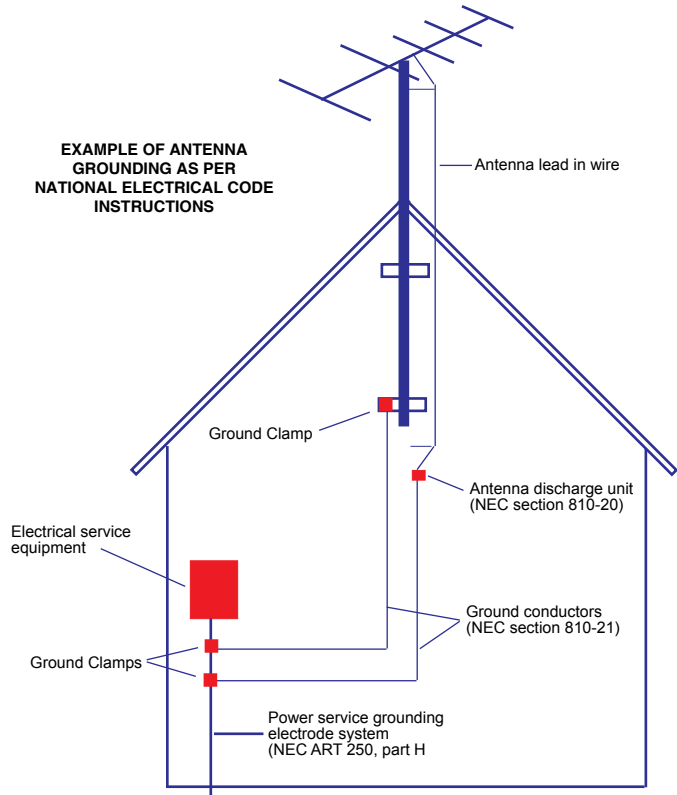

NEC - National Electrical Code

CONSUMER 90 DAY WARRANTY

The Winegard Company warrants this Winegard product against any defects in materials or workmanship within 90 (ninety) days from date of purchase. No warranty claim will be honored unless at the time the claim is made, you present proof of purchase to an authorized Winegard dealer (if unknown, please contact Winegard Company, 3000 Kirkwood Street, Burlington, IA 52601-2000, Telephone 800-288-8094).

Winegard Company (at its option) will either repair or replace the defective product at no charge to you. This warranty covers parts, but does not cover any costs incurred in removal, shipping or reinstallation of the product. The warranty does not extend to products which have been subjected to misuse, improper installation, or to damage caused by wind, lightning, ice or other occurrences over which the manufacturer has no control.

The 90 Day Warranty is provided on the condition that the equipment is properly delivered with all handling and freight charges prepaid to your Winegard dealer for return to our factory for repair or replacement. Winegard dealers will arrange for the replacement or repair and return to you without charge the product which failed due to defective material or workmanship.

WINEGARD COMPANY WILL NOT ASSUME ANY LIABILITIES FOR ANY OTHER WARRANTIES, EXPRESS OR IMPLIED, MADE BY ANY OTHER PERSON.

ALL OTHER WARRANTIES WHETHER EXPRESS, IMPLIED OR STATUTORY INCLUDING WARRANTIES OF FITNESS FOR A PARTICULAR PURPOSE AND MERCHANTABILITY ARE LIMITED TO THE 90-DAY PERIOD OF THIS WARRANTY.

The foregoing shall be the sole and exclusive remedy of any person, whether in contract, tort or otherwise, and Winegard shall not be liable for incidental or consequential damage or commercial loss, or from any other loss or damage except as set forth above.

Some states do not allow limitations on how long an implied warranty lasts, or the exclusion of limitation of incidental or consequential damages, so the above limitations or exclusions may not apply to you.

This warranty gives you specific legal rights and you may also have other rights which vary from state to state.

Rev. 2/08