

EXPANDABLE 24 VDC POWER SUPPLY



N+1 DC Power System

with Battery Backup / Charging Function

MODELS : **SEC-2430BRM**
 SEC-2440BRM
 SEC-2450BRM

INSTALLATION & OPERATING MANUAL

Please read this manual before operating your power supply.



- PROVIDES N + 1 REDUNDANCY
- ALLOWS CONNECTION OF EXTERNAL BATTERIES FOR BACKUP
- EXPAND OUTPUT POWER BY ADDING POWER MODULES
- UP TO 50 AMPS CONTINUOUS POWER
- VOLT / AMPERE METER
- OPERATION STATUS L.E.D.
- FAN FAILURE ALARM AND WARNING L.E.D.
- REMOTE MONITORING AND INDICATION
- 19" RACK MOUNT
- 2 YEAR WARRANTY / TOLL FREE TECHNICAL SUPPORT

TABLE OF CONTENTS

Topic	Page
Important safety instructions	1,2
Description and application	3
Design and principle of operation	3
Cooling and warning for fan failure	3
Front panel controls and indicators	4
Rear panel controls	4,5
Protections	5
Installation and operation	6
Operation of battery back-up	7
Output voltage adjustment	8,9
Installation and removal of modules	9,10
Trouble shooting	11,12
Limiting electromagnetic interference	13,14,15
Specifications	16
Appendix : Figures 1 to 3	17,18
Warranty information	19
Notes	20

IMPORTANT SAFETY INSTRUCTIONS

Please read before using your power supply.

CAUTION !

ALL ELECTRICAL INSTALLATIONS MUST MEET LOCAL AND NATIONAL WIRING CODES AND SHOULD BE PERFORMED BY A QUALIFIED ELECTRICIAN.

OPERATION OF COOLING FAN

THE HEAT PRODUCED IS EXTRACTED BY FORCED AIR COOLING. IN CASE ANY OF THE FANS FAILS, LIGHT AND SOUND ALARMS WILL BE ACTIVATED. IMMEDIATELY **SWITCH OFF** THE POWER TO THE UNIT TO PREVENT DAMAGE DUE TO OVER HEATING

CONNECTION TO AC OUTLET

THE POWER SUPPLY SHOULD BE OPERATED ONLY FROM A STANDARD 3 PIN 120 V AC/ 60 HZ OUTLET WITH PROPER GROUNDING CONNECTION.

SEC-2450BRM MUST BE POWERED FROM A 30A BRANCH CIRCUIT AND SHOULD BE PLUGGED INTO A 30A AC RECEPTACLE WHICH WILL ACCEPT THE 30A PLUG OF THE POWER CORD. **SEC-2440BRM** MUST BE POWERED FROM A 20A CIRCUIT AND MUST BE PLUGGED INTO A 20A AC OUTLET WHICH WILL ACCEPT THE 20A MOULDED PLUG PROVIDED WITH THE POWER CORD. **SEC-2430BRM** MAY BE POWERED FROM A 15A CIRCUIT. A 15A PLUG HAS BEEN PROVIDED SEPARATELY WHICH CAN BE USED TO REPLACE THE 20A PLUG FOR THE **SEC-2430BRM**.

CAUTION ! REPLACEMENT SHOULD BE DONE BY A QUALIFIED ELECTRICIAN. PLEASE ENSURE PROPER POLARITY OF THE CONNECTIONS AS FOLLOWS :

“ L ” LINE	BLACK WIRE
“ N ” NEUTRAL	WHITE WIRE
EARTH GROUND	GREEN WIRE

DO NOT USE EXTENSION CORD UNLESS ABSOLUTELY NECESSARY. IF AN EXTENSION CORD MUST BE USED , MAKE SURE :

1. THE PINS ON THE EXTENSION CORD'S PLUG ARE OF THE SAME NUMBER, SIZE AND SHAPE AS THOSE OF THE PLUG OF THE POWER SUPPLY CORD. NEVER USE AN EXTENSION CORD WITH A 2 PIN PLUG (THERE WILL BE NO GROUNDING CONNECTION IN THIS TYPE OF PLUG WHICH IS A SHOCK AND FIRE HAZARD)
2. THE EXTENSION CORD WIRE SIZE SHOULD BE MINIMUM 12 AWG, 20 A.

LOAD AND BATTERY CONNECTIONS

THE LOAD & BATTERY TERMINALS ON THE POWER SUPPLY HAVE A TUBULAR HOLE OF DIAMETER 8mm (0.31") WITH A SET SCREW.

ALWAYS ENSURE THAT THE CONNECTIONS ARE SECURE AND THE SCREWS ARE TIGHTENED PROPERLY.

LOOSELY TIGHTENED CONNECTIONS RESULT IN EXCESSIVE VOLTAGE DROP AND MAY CAUSE OVERHEATED WIRES AND MELTED INSULATION.

THE ENDS OF THE CABLES TO BE CONNECTED TO THE LOAD AND BATTERY TERMINALS ON THE POWER SUPPLY SHOULD HAVE PIN TYPE OF CONNECTOR FOR MAKING A FIRM CONNECTION. **4 PIECES OF PIN TYPE CONNECTORS ARE ENCLOSED WITH THE POWER SUPPLY. CRIMP THESE TO THE ENDS OF THE CABLES.**

USE MULTI STRANDED WELDING TYPE CABLE OR BATTERY CABLE (NEOPRENE SYNTHETIC INSULATION, 90°C). USE PROPER SIZE OF CABLE, AS INDICATED BELOW, TO CONNECT ANY DEVICE TO THE POWER SUPPLY. THESE CABLE SIZES ARE VALID WHEN THE DEVICE IS WITHIN 6 FT. DISTANCE FROM THE POWER SUPPLY. **THICKER WIRING WILL BE REQUIRED FOR LONGER DISTANCES. THINNER WIRES WILL CAUSE OVERHEATING AND EXCESSIVE VOLTAGE DROP :**

FOR SEC-2450BRM - 50 A

4 AWG | UP TO

FOR SEC-2440BRM - 40 A

6 AWG | 6'

FOR SEC-2430BRM - 30 A

8 AWG | DISTANCE

ENSURE THAT THE AC POWER IS SWITCHED OFF WHEN ANY DEVICE IS BEING CONNECTED TO THE POWER SUPPLY.

DO NOT ALLOW THE ENDS OF THE POSITIVE AND NEGATIVE WIRES TO TOUCH EACH OTHER.

FUSE REPLACEMENT

ENSURE PROPERLY RATED FUSE (250 V, 4A) IS USED IN EACH OF THE MODULES.

ENVIRONMENT

DO NOT EXPOSE POWER SUPPLY TO RAIN, SNOW OR WATER SPRAY

DIS-ASSEMBLY AND REPAIR

THE POWER SUPPLY SHOULD BE DISASSEMBLED OR REPAIRED BY A QUALIFIED TECHNICIAN. INCORRECT REASSEMBLY OR REPAIR MAY RESULT IN A RISK OF ELECTRIC SHOCK OR FIRE WHICH MAY RESULT IN PERSONAL INJURY AND PROPERTY DAMAGE.

DESCRIPTION

This is a 19 inch Rack Mount Power Supply which converts 120 V , 60 Hz. AC power into regulated 28 V DC , +/- 1% (At module output*) delivering up to a maximum of 50 A continuous (up to 57.5 A surge) with 5 Base Level PCB Modules. There is provision to connect the power supply to an external battery for backup power in the case of an AC power failure and re-charge the battery when AC power resumes.

*Voltage at output terminals Load+ & Load-will be 27.6V nominal (Please see page 7 for explanation.)

APPLICATIONS

The unit is designed for the following applications:

1. N+1 redundant systems
2. Future power level expansion
3. Uninterrupted DC output when used in conjunction with an external battery backup.

DESIGN AND PRINCIPLE OF OPERATION

The unit is designed using advanced switch mode technology and load share circuitry for high reliability, high efficiency and minimum size and weight. It is modular in construction consisting of up to 5 Base Level PCB Modules (referred to as **PSM** "POWER SUPPLY MODULES") that are connected for parallel operation with true current sharing . Each module is a stand alone power supply which delivers up to a maximum of 10 A continuous (11.5A surge) . By equalizing the output currents, uniform thermal stress of the individual modules is also ensured which has utmost importance for long term reliability of electronic components. The operating principle of the load share mechanism is to measure the output current of each individual module and to be able to modify the output voltage of the units until all the participating modules deliver equal output currents. Each module is required to be interconnected with each other to a common "**SHARE BUS**" through a pair of parallel pins marked "**JUMP1**" and jumper wires (Fig. 1 & 2). Typically, the output currents for the paralleled units will be within 10% of each other at full output current. The output is delivered through schottky isolating diodes to enable connection of external battery for uninterrupted back-up power.

- **SEC-2450BRM has 5 modules of 10A each = 50 Amps**
- **SEC-2440BRM has 4 modules of 10A each = 40 Amps**
- **SEC-2430BRM has 3 modules of 10A each = 30 Amps**

COOLING AND WARNING FOR FAN FAILURE

The heat generated due to internal power dissipation is removed by forced cooling through two high power D.C. fans mounted at the back of the unit which suck air from the vents on the sides of the unit & blow outwards from the rear of the unit.

IT IS EXTREMELY IMPORTANT THAT THE DISCHARGE SIDE OF THE FANS AND THE SUCTION SIDES OF THE VENT HOLES ARE NOT BLOCKED.

A warning circuit monitors the operational condition of the fans. In case of a fan failure, a buzzer will sound and the red LED indicating "TEMP. FAULT" will light up. The unit should be switched off immediately and the defective fan should be replaced. **NEVER LOAD THE UNIT WHEN THERE IS AN AUDIBLE ALARM AND THE TEMP. FAULT LED IS ILLUMINATED.**

FRONT PANEL CONTROLS AND INDICATORS

The following controls and indicators are provided on the front panel :

1. **POWER ON/OFF SWITCH / BREAKER.** The rocker switch will illuminate when switched on. A 20A circuit breaker is built in to provide protection on the input side against overload
2. **VOLTMETER / AMMETER.** A combined voltmeter and ammeter are provided. The function can be switched by the volt / amp switch
3. **METER CHANGE-OVER SWITCH.** Switches the combined meter between ammeter and voltmeter
4. **L.E.D " PSM STATUS (1 to5)".** During normal operation, the green LED of each Power Supply Module (PSM) will light. In case a power supply module (PSM) fails, its corresponding LED will go off. LED 1 is for the left most module (near the on/off switch)
5. **L.E.D " TEMP. FAULT "** : In case of fan failure, this red LED lights up and a buzzer is sounded.

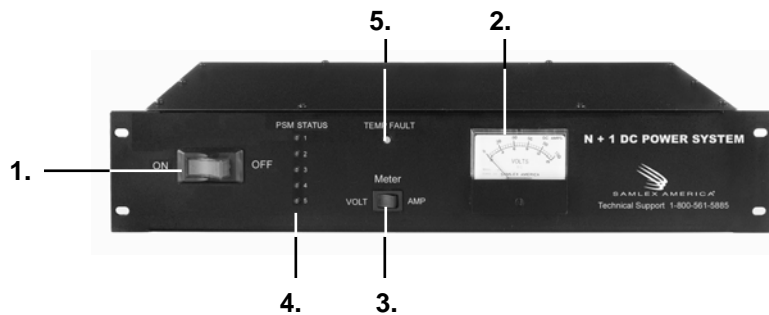

REAR PANEL CONNECTORS

The following output connectors have been provided.

1. Load+ (Positive), Load- (Negative) LOAD CONNECTORS.
For connecting to the D.C. Load
2. Battery+ (Positive), Battery- (Negative) BATTERY CONNECTORS.
For connecting external battery for un-interrupted D.C. power to the load.

3. REMOTE MONITORING AND INDICATIONS . A 25 pin D-sub connector has been provided for remote monitoring and indication. Pin connections are given below. Pins 2 and 16 are meant to indicate availability of input AC power. Current indication on pins 18 & 6 is 0.5mV per Amp. (Shunt ratio 25mV / 50A)

ITEM NUMBER ID FUNCTION

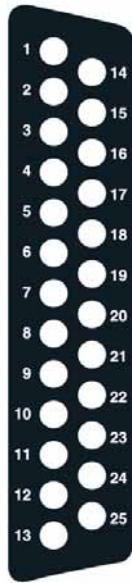

1	Pin 2	Black	AC 5V 0.25A
	Pin 16	White	AC 5V 0.25A
2	Pin 12	Orange	Temp Fault Led +
	Pin 19	Green	Temp Fault Led -
3	Pin 7	Gray	PCB 1 Power LED+
	Pin 20	Violet	PCB 1 Power LED-
4	Pin 8	Violet	PCB 2 Power LED+
	Pin 21	Blue	PCB 2 Power LED-
5	Pin 9	Blue	PCB 3 Power LED+
	Pin 22	Green	PCB 3 Power LED-
6	Pin 10	Green	PCB 4 Power LED+
	Pin 23	Yellow	PCB 4 Power LED-
7	Pin 11	Yellow	PCB 5 Power LED+
	Pin 24	Orange	PCB 5 Power LED-
8	Pin 25	Red	DC Volt Output +
	Pin 13	Black	DC Volt Output -
9	Pin 18	Gray	DC Current +
	Pin 6	Blue	DC Current -

PROTECTIONS

SHORT CIRCUIT PROTECTION : In the event of a short circuit, the PWM controller will be shut down and the output will drop to near 0 V. The green LEDs will flash. The unit will reset automatically once the short circuit condition is removed

CURRENT LIMITING : The unit will enter this mode when the load tries to draw more than the limiting values of currents as shown in the specifications. Under this condition, there will be loss of voltage regulation and the output voltage will drop. The "PSM STATUS" LED will, however, remain illuminated, but dimmed. **The unit will reset automatically as soon as the overload condition is removed .**

INPUT SURGE PROTECTION : The unit is protected against input voltage surges.

FAN FAILURE WARNING INDICATOR AND ALARM : If forced air cooling is stopped due to failure of any one or both the fans, the red “ TEMP. FAULT “ LED will be illuminated and an alarm buzzer will be activated. The unit is required to be switched off immediately as loss of forced air cooling may result in major damage to the unit.

INSTALLATION AND OPERATION

1. Ensure that the space where the unit is to be installed has adequate air supply for cooling. There should be no obstruction on the suction side of the fans at the sides or on the discharge side vent holes on the back of the unit.
2. Switch off the on/off switch on the front panel.
3. Switch off all the D.C. load(s) to be connected to this unit.
4. Connect the Load+ and Load- at the back of the unit to the D.C. load(s) or the DC bus. Ensure the wire or bus bar used to connect the load or the D.C. bus is of proper cross-section to carry the desired load current. Tighten the screws to ensure firm connection.
5. In case external battery is required for battery back-up, connect the positive of the battery to Battery+ and negative of the battery to Battery-. (See details under “operation of the battery back-up”)
6. Plug the unit into the 120 V, 60 Hz standard AC outlet . The outlet should be rated at 30A for SEC2450BRM, 20A for SEC-2440BRM and 20/15A for SEC-2430BRM.
7. Switch on the unit by pressing the power on/off switch to on position. The switch will be illuminated confirming that input power is available.
8. A short beep may be generated by the temperature fault alarm circuit on powering on the unit . This is normal. Please disregard.
9. Switch the volt/amp change-over switch to the “**VOLT**” position. The voltmeter should read 27.8 V on no load (Please see explanation on Page 7)
10. Switch on the D.C. loads. The output voltage should be 27.6 V nominal (Please see explanation on Page 7)
11. Switch the volt/amp meter switch to “**AMP**” position to read the load current. Ensure that the load current is within the total rated continuous load of the modules installed.

OPERATION OF BATTERY BACK-UP

WARNING!

THE BATTERY SHOULD BE LOCATED IN A WELL VENTILATED AREA TO SAFELY DISSIPATE HYDROGEN GAS PRODUCED DURING THE CHARGING PROCESS.

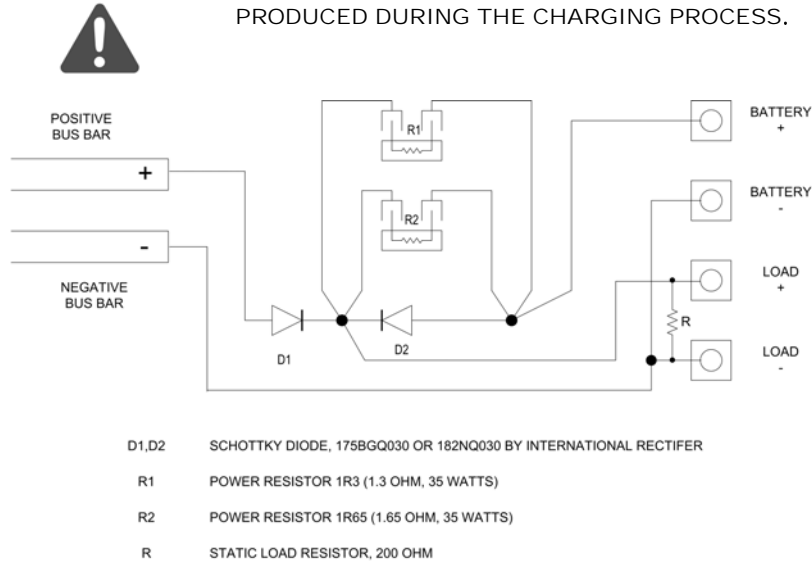

FIGURE A

Please refer to the schematic at fig. A above.

Regulated output voltage of 28 V +/- 1% from the modules (measured at screw terminals **S5** and **S6** (Fig.1) is fed to the positive and negative DC bus bars and from there to the output terminals **LOAD+** and **LOAD-** through the isolating Schottky Diode **D1**. Although the output voltage at the module terminals **S5** and **S6** (Fig.1) or at the common DC bus bar (before the Schottky Diode **D1**) is tightly regulated at the preset value of 28 V +/- 1%, the voltage at the output terminals **Load +** and **Load -** will vary slightly due to the forward voltage drop of the isolating Schottky Diode **D1** and the drop along the DC bus bar and wiring. **The voltage at the output terminals **LOAD +** and **LOAD -** will be as follows :**

At no load	Approx. 27.8 V
At 10 A load	Approx. 27.6 V
At loads > 10 A	Approx. 27.6 V minus 5 mV per Amp above 10A

When there is a requirement of un-interrupted D.C. power to the load, an external battery may be connected at the terminals Battery + and Battery -. When the input A.C. power is available, the load current is supplied by the power supply through isolating Schottky Diode **D1**. At the same time, the battery is charged through resistors **R1** & **R2**. (These resistors will limit the maximum charging current to about 8 Amperes.)

If the input A.C. power is interrupted, the external battery feeds the load instantaneously through the Schottky Diode **D2** (**D2** will by-pass the resistors **R1** & **R2**). Voltage available to the load will be approximately 0.4V lower than the battery voltage due to forward voltage drop across **D2**.

When the input A.C. power returns, the battery will be isolated and the load current will once again be supplied by the power supply. The discharged battery will re-charge through **R1** & **R2**.

NOTE: The value of charge limiting resistors is based on a typical 100AH deep cycle marine battery. If a different type of battery is used, the value of the resistor should be adjusted to meet associated charging requirements.

OUTPUT VOLTAGE ADJUSTMENT

NOTE : The voltages indicated are at no load and are measured at any of the module output pads under **S5** and **S6** or at the DC bus before the Schottky Diode **D1**.

Parallel Operation Under Forced Current Share Control

The output voltage of each module measured at the module output pads under **S-5** and **S-6** (See Fig.1) is factory pre-set at 28 V. A precision multi turn potentiometer **VR1** is provided for fine adjustment of the output voltage of the module (The adjustment range is 26.8 V to 28.5 V).

For the forced current share control to work properly, it is important that the output voltage of each module connected in parallel is exactly the same. When 2 or more modules are operating in parallel under forced current share control and if the output voltage of any module is below 28 V, it's current share control circuitry will not function properly and it's LED will start flashing. The LEDs of the other modules which are putting out 28 V will remain continuously lighted and the output voltage of the common DC bus (before the Schottky Diode **D1**) will be 28 V.

If the output voltage of any module is higher than 28 V, it's LED will remain continuously lighted but the LEDs of all the other modules will flash randomly. The output voltage of the common DC bus (before the Schottky Diodes **D1**) will read the higher voltage of this module.

Adjusting the output voltage of the modules at no load

NOTE : The output voltage is adjusted by multi turn potentiometer **VR1** (Fig.1). As the adjustment is very fine, multiple turns will be required even for small voltage change. Turn clockwise for decreasing and anti clockwise for increasing . The adjustment range is 26.8 V to 28.5 V

As explained under **OPERATION OF BATTERY BACK UP** on page 7, although the output voltage at the module terminals **S5** and **S6** (Fig.1) or at the common DC bus (before the Schottky Diode **D1**) is tightly regulated at the preset value of 28 V +/- 1%, the voltage at the output terminals **Load +** and **Load -** will vary between 27.8 V at no load to 27.45 V at full load of 50 A due to the forward voltage drop of the isolating Schottky Diode **D1** and the drop along the DC bus and wiring.

The output voltage of the paralleled modules or the common DC bus (before the Schottky Diodes **D1**) can be adjusted between 26.8 V and 28.5 V by adjusting the voltage of each module individually as per the following procedure (This procedure is explained for SEC-2450BRM which has 5 modules). **The voltage at the output terminals LOAD + and LOAD – will be as follows :**

At no load	Module voltage minus 0.2V
At 10 A load	Module voltage minus 0.4V
At loads > 10 A	Module voltage minus 0.4V minus 5 mV per Amp above 10A

Procedure

- Switch off the unit and unplug the power cord.
- The output voltage of each individual module is adjusted one by one starting from the left most module – Module 1 and progressing to the right most module – Module No. 5 (for SEC-2450BRM). **AC input is connected only to the module being adjusted. AC input to the remaining modules is disconnected**
- Remove the AC input connections (female quick connect terminals connected to the L and N male tab terminals on the modules – Fig. 1) from Module Nos. 2, 3, 4 and 5. Temporarily insulate these female quick connect terminals with insulating tape for safety. **Now, only Module No. 1 can be energized.**
- Switch on the power supply. **Only Module No. 1 will operate.** Adjust the output voltage of this module to the desired value with the help of potentiometer **VR1** (Fig.1) Measure the voltage at the screw terminals **S5** and **S6** (Fig.1)
- Switch off the power supply. Remove the AC input connection from Module No. 1. Temporarily insulate these terminals with insulation tape. Remove temporary insulation from the AC connectors for Module 2 and connect them to Module 2. **Now only Module 2 can energize.**
- Switch on the power supply. **Only Module No. 2 will operate.** Adjust the output voltage of this module to the desired value with the help of potentiometer **VR1** (Fig.1). Measure the voltage at the screw terminals **S5** and **S6** (Fig.1)
- Continue to adjust the voltage of the remaining Module Nos. 3, 4 and 5 individually as explained above making sure that **the AC power is connected to only the module being adjusted.**
- After all the modules have been adjusted to the same output voltage, connect the AC input back to all the five modules.
- Power on the unit and check that all the 5 “**PSM Status**” LEDs are lighted. This will confirm that the voltage adjustment has been completed successfully

INSTALLATION AND REMOVAL OF POWER SUPPLY MODULES

NOTE: INSTALLATION AND REMOVAL OF POWER SUPPLY MODULES SHOULD BE PERFORMED ONLY BY QUALIFIED PERSONNEL

CAUTION !

Before removing a defective module or installing a new one, switch off the 120 V , 60 Hz input power and unplug the power cord from the mains outlet.

NOTE :

Please refer to the layout diagram of the module at Figure. 1 located on page 17.

UPGRADING TO HIGHER CAPACITY – INSTALLING ADDITIONAL MODULE(S)

Additional optional module(s) (**Model No. SEC-1024MPSB**) can be added to upgrade the output current capacity of SEC-2430BRM and SEC-2440BRM by steps of 10A to a maximum of 50A. For example, an SEC-2430BRM (30 A, with 3 modules) can be upgraded to SEC-2440BRM (40A) by adding 1 more module or to SEC-2450BRM by adding 2 more modules .

The optional module **SEC-1024MPSB** comes with an LED and LED holder. It's output voltage is pre-set at 28 Volts

The procedure to install additional module(s) is as follows :

1. Remove the top cover plate by unscrewing the 10 screws
2. Each module sits on 6 stand-offs relative to the holes **S1** to **S6** (Fig.1). Additional module(s) are to be installed in the vacant space(s) adjacent to the right of the existing module. Remove the screws from the 6 stand-offs for the adjacent vacant space for the module.
3. Place the module on the stand-offs with the **L** and **N** terminals (Fig.1) towards the front panel. Align the holes and fix the module with the 6 screws. **WARNING ! Please ensure that screws S5 and S6 are very tight as the pads under these two screws connect the output of the module(s) to the DC bus bar underneath. A loose connection under these screws will result in sparking , overheating and consequent damage to the module**
4. Each module has independent AC power input wires. Locate unused pair of AC input wires. (Black and white with insulated female quick connect terminals). Connect the black wire to the male tab terminal marked **L** (Fig.1) and white wire to the male tab terminal marked **N** (Fig.1)
5. Green LED indication for proper operation of the module is provided from 2 pin male quick connect terminals marked LED1 and LED2 (Fig.1). One LED terminal is used for the front panel LED under "PSM Status (1 to 5)" and the other for remote indication through the D-Sub connector. Connection to the D-Sub connector for remote indication is made using color coded pair of wires for each of the 5 modules (Please see the colour code for PCB 1 to 5 under **REMOTE MONITORING AND INDICATION** on Page 5) . An LED holder and a green LED with wire and female quick connect terminal are provided with the new module for connecting to the front panel. The vacant hole(s) for the front panel LEDs are closed with plastic plug(s). Remove the plastic plug from the vacant hole for the LED under the existing bottom most LED. Insert the LED holder in this hole from the outside. Insert the green LED from the inside and push it till it locks. Connect the female quick connect terminal of the LED to the male quick connect terminal marked LED1 / LED2 (Fig.1). If remote LED indication is also required, then connect the female quick connect terminal of the corresponding colour coded wire for the remote LED connection to the male quick connect terminal marked LED1/ LED2 (Fig.1)
6. All the connected modules operate under forced current share control through a daisy chained **SHARE BUS** formed by interconnecting each module through the male quick connect terminal marked **JUMP1** (Fig.1 & 2). A wire with 5 female quick connect terminals is provided for the above connection. Locate the unused female quick connect terminal(s) of this wire and connect it to the male quick connect terminal marked **JUMP1** (Fig.1)
7. Use cable ties to secure all loose wiring
8. Replace the top cover. Power on the unit and confirm that the "**PSM Status**" LEDs of the newly installed modules are lighted.

REMOVING A DEFECTIVE MODULE

1. Remove the top cover plate by unscrewing the 10 screws.
2. Locate defective module. Remove the 6 screws from S1 to S6.
3. Remove the input power supply wires from terminals "L" and "N". Insulate the wire terminals with insulating tape
4. Remove the LED wire connection from terminals "LED 1 & LED 2" .
5. Remove the "SHARE BUS" wire female socket connector from the terminal "JUMP1". If the defective module is not being replaced immediately and if the unit is required to be operated without this defective module,
IT IS MANDATORY TO SHORT THE TWO FEMALE SOCKETS ON THIS UNUSED FEMALE CONNECTOR WITH A SHORTING LINK. (SEE FIG. 3) THIS WILL ENSURE THAT THERE IS NO BREAK IN THE "SHARE BUS" DAISY CHAIN AND THAT ALL THE "JUMP1" TERMINALS ARE INTERCONNECTED.
6. The module can now be removed.

TROUBLE SHOOTING

POWER ON/OFF SWITCH DOES NOT LIGHT WHEN SWITCHED ON

- Check that power is available in the AC outlet
- Check that the power cord plug is properly plugged in

POWER SWITCH TRIPS

- The breaker , which is a part of the power on/off switch, has tripped due to abnormal condition . Call technical support

"TEMP. FAULT" LED LIGHTS UP AND BUZZER IS SOUNDED

- One or both of the fans have stopped
Forced cooling has failed due to defect in the cooling fan(s). Switch off the unit immediately . Fan(s) needs to be replaced.
DO NOT USE THE UNIT TILL THE DEFECT IS RECTIFIED. IT IS PROHIBITED TO USE THE UNIT WITHOUT FORCED COOLING. Call technical support.
- If both the fans are running, the small fan status monitoring PCB may be defective. Call technical support.

“ PSM STATUS ” LED(S) DOES NOT LIGHT UP

- The associated module has become defective. The unit will still operate normally as the remaining working modules will share a higher load. The unit will go into current limit and the output voltage will drop if the load drawn is more than the combined maximum rated output of the remaining modules. Reduce the load so that the maximum load drawn is less than the combined maximum rated output of the working modules. Remove the defective module and replace with a new module.

OUTPUT VOLTAGE DROPS

- The unit has gone into current limit as the load being drawn is more than the combined maximum rating of the working modules. This may also result if one or more modules has failed . Check that all the modules are operating properly. If a module has failed, its green LED would extinguish. Reduce the load drawn to a value less than the combined maximum rated output of the working modules. If the voltage does not rise to the rated voltage of 27.6 V, then switch off all the loads. If the voltage in this condition is also low, switch off the unit and contact technical support

ONE OR MORE “PSM STATUS” LED(S) FLASHES

- The output voltage of the individual modules is not the same or the forced shared control circuitry of the module(s) is defective. Adjust the voltages of the modules to 28 V as explained on page 8. If the problem still exists, contact technical support.

LIMITING ELECTROMAGNETIC INTERFERENCE (EMI)

1. Switched mode power supplies (SMPS) employ high frequency switching and thus, are a source of radio interference, a recipient of radio interference and a conduit of radio interference. (Older linear type transformer based power supplies do not employ high frequency switching voltages and will be quieter as compared to switching type of supplies).
2. The primary emission sources originate in the switching devices due to their fast switching current transitions: harmonics of the switching frequency and broadband noise created by under-damped oscillations in the switching circuit. The secondary source is from the bridge rectifier, both rectifier noise and diode recovery. The AC input rectifier / capacitor in the front end of the switching power supplies (excepting those with power factor correction) are notorious for generating power supply harmonics due to the non linear input current waveform. The noise is both conducted and radiated through the input power cord and the DC output wiring to the radio. Filters are used to limit the noise to acceptable level.
3. Switching power supplies are also recipients of radio interference. The normal operation of the power supply can be disturbed due to RF noise getting coupled into the power supply. Thus, the power supply may generate excessive RF noise and lose output voltage regulation due to excessive transmitter energy being coupled through the AC / DC lines to the power supply's regulator feedback path. This may be due to antenna being too close or due to the antenna or feed system not radiating properly. First check the antenna system SWR. Then, if necessary, relocate either the antenna or the power supply farther apart.
4. The receiver may "hear" the power supply. A slowly moving, slightly buzzing carrier heard in the receiver may be caused by the antenna being too close. As with the transmitter related noise pick up, a loose coaxial connector or a broken or a missing ground may aggravate this problem. Normally these noises will be below the background or "band" noise. Increase the separation between the power supply and the receiving antenna. Use an outdoor antenna. This will reduce the amount of signal picked up from the power supply and also increase the amount of the desired signal.

5. The conducted RF noise from these power supplies is limited to the maximum allowable levels by internal filtration. The filtered RF noise currents are by-passed to the chassis of the power supply. The chassis is, in turn connected to the earth ground pin of the AC input power cord (for Class 1 units). Thus, the filtered noise currents are intentionally leaked to the earth ground. This is termed as the "Earth Leakage Current". For safety against electric shock, this earth leakage current is also required to be limited. It will be seen that these two requirements are conflicting.

NOTE:

In some cases, to prevent electric shock hazard due to abnormal leakage current (like in marinas, spas, hot tubs, wet spaces etc.), the AC outlet circuits / receptacles in these areas are served through a GFCI (Ground Fault Circuit Interrupter). This GFCI is normally set to trip when it senses an earth leakage current > 5 mA. A single GFCI may be serving multiple AC outlet circuits / receptacles and therefore, will be sensing the sum of all the leakage currents of the devices connected to these. As the switching power supplies have intentional leakage current as explained above, it may trip a GFCI feeding multiple AC outlet circuits / receptacles. In such cases, disconnect devices connected to the other AC outlet circuits / receptacles served by this GFCI.

6. Following additional guidelines may be followed to reduce the effects of RF noise:
 - a. Use additional appropriate AC radio frequency interference (RFI) power line filter immediately before the ac input of the power supply.

These cord sets, with integral line interference filters, reduce common and differential mode interferences over a wide frequency range. Because they are shielded, they are also effective against radiated interferences. In addition to the built-in filter networks, the cable conductors are coated with an RF absorbing ferrite compound. This provides additional attenuation at high frequencies that is lacking in most regular LC filters. The RF absorption of the ferrite-coated cable avoids resonance's at high frequencies, reducing the conducted and radiated RF noises even further

- b. Use additional appropriate DC radio frequency interference (RFI) power line filter immediately after the dc output of the power supply.

- c. Twist the positive and negative wires from the output of the power supply to the radio
- d. The DC side positive and negative outputs of these power supplies are isolated from the chassis. As explained at paragraph 5 above, the noise currents are filtered to the chassis ground and the chassis ground is connected to the earth ground through the earth ground pin of the AC power outlet receptacle. Avoid connecting (referencing) the DC negative output terminal of the power supply to the earth ground.
- e. Connect a 1/4" wave length of wire on the negative terminal of the power supply. Connect one end of the wire to the negative terminal and leave the other end free. The wave length corresponds to the wave length of the interfering frequency. (May not be practical for long wave lengths)

[Formula: Wave length (Meters) = 300 / frequency in MHz

SPECIFICATIONS

	SEC-2430BRM	SEC-2440BRM	SEC-2450BRM
NO. OF MODULES	3	4	5
INPUT VOLTAGE RANGE	105 TO 125 V AC, 60 HZ		
INPUT CURRENT	12A	16A	20A
OUTPUT VOLTAGE (At terminals L+ & L- , See page 7)			
NOMINAL, VDC	←—————→	27.6V	—————→
NO LOAD, VDC	←—————→	27.8V	—————→
FULL LOAD, VDC	27.5V	27.45V	27.4V
OUTPUT REGULATION (At module output S5, S6—Fig. 1)	1%		
OUTPUT CURRENT			
CONTINUOUS	30A	40A	50A
SURGE	34.5A	46A	57.5A
OUTPUT CURRENT LIMIT	36A	48A	60A
OUTPUT RIPPLE, PEAK TO PEAK	←—————→	150mV	—————→
OUTPUT NOISE , PEAK TO PEAK	←—————→	LESS THAN 1.5V	—————→
COOLING	FORCED AIR, 2 FANS		
OPERATING TEMPERATURE	0 TO 40 C		
PROTECTIONS			
SHORT CIRCUIT	YES		
CURRENT LIMIT	YES		
FAN FAILURE	LED AND BUZZER		
INPUT SURGE SUPPRESSION	YES		
FUSE	MODULE FUSE – 250 V, 4 A UNIT HAS SWITCH / BREAKER 250 V, 20 A		
DIMENSIONS	19" X 15.9" X 3.6"		
WEIGHT, LBS	22	23.5	25

NOTE: SPECIFICATIONS SUBJECT TO CHANGE WITHOUT NOTICE

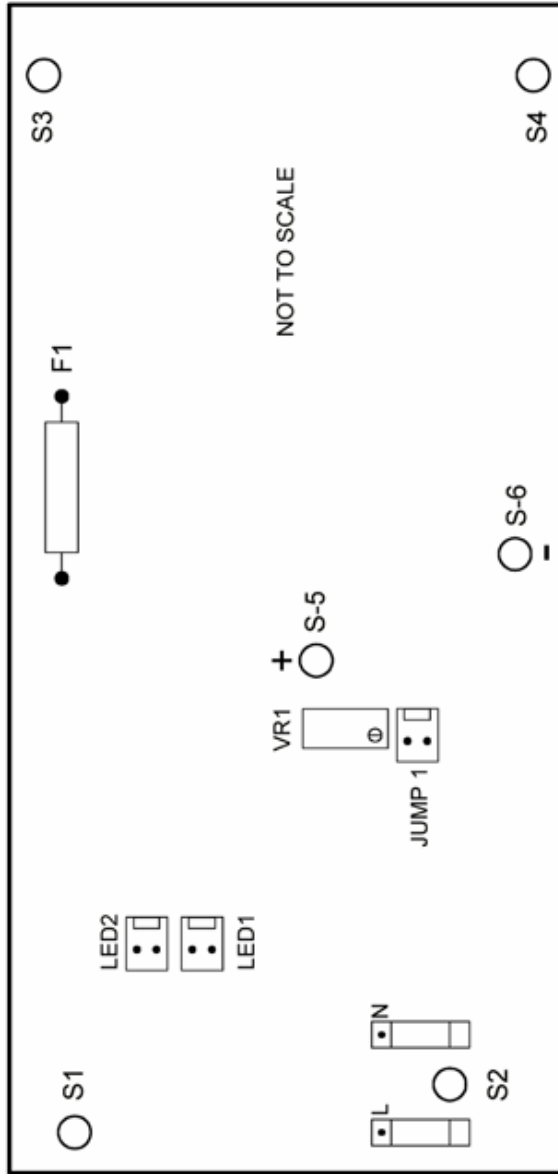

Figure 1.

Figure 1 - Layout of Power Supply Module

- S1 to S4 Holes for 4 screws to fasten the module to the chassis
- S5 & S6 Holes for 2 screw to connect to the Positive and Negative output BUS Bars.
- L & N L (line) and N (neutral) terminals for 120V, 60 Hz input power supply wires
- LED 1, 2 Terminal for "LED" PSM status
- JUMP 1 Jumper terminal for connecting share BUS wire
- F1 Fuse
- VR1 Potentiometer for output voltage adjustment

Figure 2.

“ Daisy Chaining “ of “Share BUS “ jumpers (Jump 1)

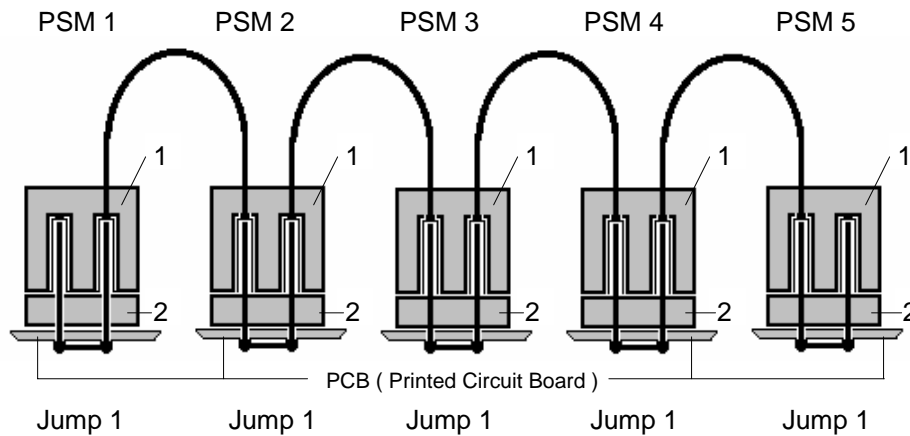

1. Female socket terminal of the daisy chain.
2. Male 2 pin terminal marked “Jump 1“ on the Power Supply Module.

CONTINUITY OF “ DAISY CHAIN “ CONNECTIONS

Removing any end module (example PSM1/PSM5 in Fig. 2 above) does not break the daisy chain. However, if any of the sandwiched modules (example PSM 2,3,4) is removed, the daisy chain is broken. In this case, the unused female socket for the missing sandwiched module(s) should be shorted by inserting a shorting link to prevent a break in the daisy chain (Fig.3)

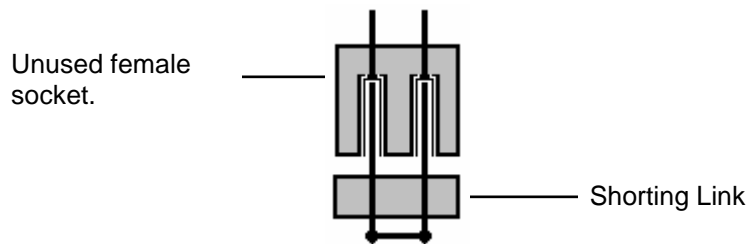

Figure 3.

2 YEAR Limited Warranty

This product manufactured by Samlex America, Inc. (the "Warrantor") is warranted to be free from defects in workmanship and materials under normal use and service. This warranty is in effect for 2 years from the date of purchase by the user (the "Purchaser")

If the defective product is within the warranty period, the Purchaser should contact the place of purchase to obtain a Return Authorization Number.

The defective part or unit should be returned at the Purchaser's expense to the authorized location. A written statement describing the nature of the defect, the date of purchase, the place of purchase, and the Purchaser's name, address and telephone number should also be included.

If upon the Warrantor's examination, the defect proves to be the result of defective material or workmanship, the equipment will be repaired or replaced at the Warrantor's option without charge, and returned to the Purchaser at the Warrantor's expense if within the warranty period.

No refund of the purchase price will be granted to the Purchaser, unless the Warrantor is unable to remedy the defect after having a reasonable number of opportunities to do so.

Warranty service shall be performed only by the Warrantor. Any attempt to remedy the defect by anyone other than the Warrantor shall render this warranty void.

There shall be no warranty for defects or damages caused by faulty installation or hook-up, abuse or misuse of the equipment including exposure to excessive heat, salt or fresh water spray, or water immersion.

No other express warranty is hereby given and there are no warranties which extend beyond those described herein. This warranty is expressly in lieu of any other expressed or implied warranties, including any implied warranty of merchantability, fitness for the ordinary purposes for which such goods are used, or fitness for a particular purpose, or any other obligations on the part of the Warrantor or its employees and representatives.

There shall be no responsibility or liability whatsoever on the part of the Warrantor or its employees and representatives for injury to any persons, or damage to person or persons, or damage to property, or loss of income or profit, or any other consequential or resulting damage which may be claimed to have been incurred through the use or sale of the equipment, including any possible failure of malfunction of the equipment, or part thereof.

The Warrantor assumes no liability for incidental or consequential damages of any kind.

Solid Signal
www.solidsignal.com
info@solidsignal.com
1.877.312.4547 (EST)

Attach copy of receipt here for your records:



Date purchased:
Purchased from:
Additional notes:



Solid Signal
www.solidsignal.com
info@solidsignal.com
1.877.312.4547 (EST