

DIRECTV® Antenna Installation Manual

SlimLine™ Multi-Satellite Dish Antenna with Integrated Ka/Ku LNBS and Built-in Multi-Switch

Introduction

This Multi-Satellite Dish antenna requires specialized tools and equipment for successful installation, therefore we recommend professional installation only. This manual is a guide for the professional installer.

The DIRECTV *SlimLine* Multi-Satellite Dish antenna is primarily designed for use with up to four independently operating DIRECTV Ka/Ku MPEG-4 HD Receivers but will function with other DIRECTV receivers as well. Along with the receiver User Manual, this guide will provide the information needed to successfully install and operate the DIRECTV System. Throughout this manual, this DIRECTV *SlimLine* Multi-Satellite Dish Antenna may also be referred to as the "antenna".

For best results, we suggest you read carefully through these pages first before beginning installation. The guide is intended for individuals experienced in performing the various tasks described, including:

- Determining an antenna location with a good southerly view of the satellites
- Climbing a ladder and working on your roof
- Observing safe working practices around heights and electrical hazards
- Determining if there are water pipes, gas lines or wiring hidden in walls where you are going to drill
- Using a power drill to drill holes into a structure
- Routing coaxial cable(s) through foundation, wall, under-floor, attic or interior walls
- Safely lifting and securing the 30-lb. antenna assembly
- Grounding the antenna and cable(s) as recommended in the National Electric Code (NEC)*

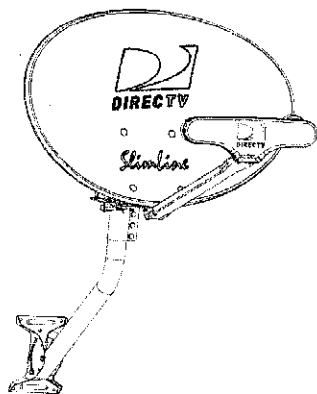

Safety Information

Local and National electrical codes (NEC) require the antenna and the coaxial cables to be connected to a grounding electrode. Improper installation may seriously damage the equipment or the building, as well as cause injury or death to you. For your own safety, follow these important safety rules or contact a licensed inspector or electrician in your area for assistance:

- If you will be mounting the antenna in a location where it will be difficult or dangerous to view the attached bubble level (see page 6), use a small mirror or plumbing level instead. DO NOT risk falling.
- Perform as many functions as possible on the ground.
- Do not install the antenna on a rainy, snowy or windy day.
- Make sure there are no people, pets, etc. below when you are working on the roof.
- Watch out for power lines which may be overhead, underground and/or hidden behind walls, keeping safely clear of them with ladders, antenna and tools during installation.

The Federal Communications Commission (FCC) has ruled that a local government or homeowner's association may not prevent the installation of satellite antennas one meter or smaller in diameter, unless legitimate safety restrictions such as fire codes are in effect. Call FCC tel: (202) 418-0163; See FCC Web sites at <http://www.fcc.gov/cgb/satellite.html> or <http://www.fcc.gov/mb/facts/otard.html> for more information.

ACTIVATION OF PROGRAMMING MAY BE SUBJECT TO CREDIT APPROVAL AND REQUIRES VALID SERVICE ADDRESS, SOCIAL SECURITY NUMBER AND/OR MAJOR CREDIT CARD. DEPOSIT OR PREPAYMENT MAY BE REQUIRED. Programming subject to change. You must be physically located in the U.S. to be an authorized DIRECTV customer. DIRECTV services not provided outside the U.S. DIRECTV programming is sold separately and independently of DIRECTV System hardware. A valid programming subscription is required to operate DIRECTV System hardware. Activate your DIRECTV programming today at 1-800-DIRECTV (1-800-347-3288).

*NEC is published by the National Fire Protection Agency, 1 Batterymarch Park, Quincy, Massachusetts, 02269-9101 and may be available at your public library.

Antenna Assembly Overview

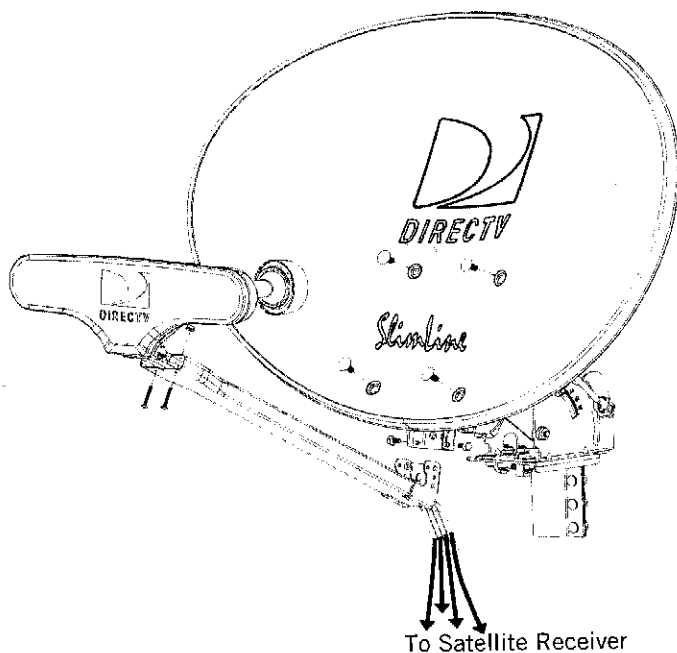

Contents of Package

Multi-Satellite Dish Reflector

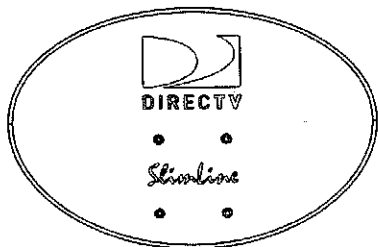

99°/101°/103°/110°/119° Integrated LNB
with 4 outputs

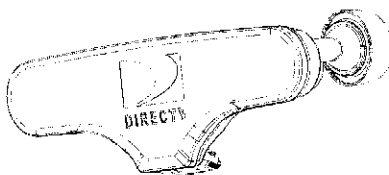

Dish Bracket

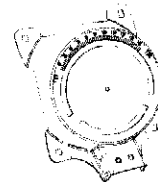

LNB Feed-Arm



EZALIGN™ Mast

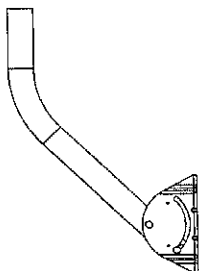

Dish Mounting Hardware

5/16" X 5/8" Round Flat Head Bolt - 4EA
5/16" Serrated Flange Nut - 4EA



Feed Arm Hardware

1/4" * 1/2" Hex Head Bolt 4EA



LNB Mounting Hardware

#8-32UNC x 1-1/4" Hex Head screw - 2EA
#8-32 Serrated Flange Nut - 2EA



AZ/EL Mount/Mast Clamp Assembly
(Not included, packed separately)

CalAmp# 151561 or WNC# BAU
packaged with:

16" X 5/8" Hex Head Bolt - 3EA
5/16" Flat Washer & 5/16" Lock Washer - 3EA

Grounding Screw

#10-32UNF X 1/2" Screw - 1EA

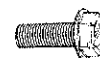

Tools Required

1/2" Nut Driver



Adjustable Wrench

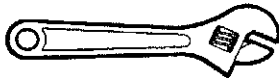

Screwdriver (Philips)



Magnetic Compass

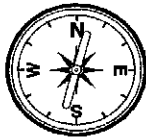

In-Line Satellite Signal Meter

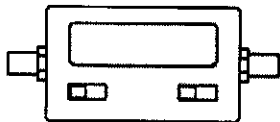

Electric Drill and Bit

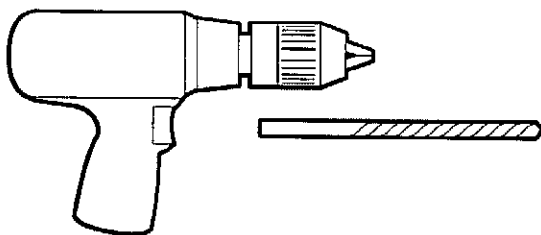

Steps for Installation

- 1 Determining Coordinates for Aiming Antenna.....page 4
- 2 Finding Suitable Antenna Sitepage 5
- 3 Installing EZALIGN™ Mast.....page 6
- 4 Assembling/Adjusting Antenna on Ground.....page 7
- 5 Attaching Antenna to Mast.....page 7
- 6 Routing RG-6 Cable(s).....page 7
- 7 Grounding Cable and Antennapage 8
- 8 Attaching Integrated LNB to Antenna.....page 8
- 9 Aiming and Fine-tuning Antenna.....page 9

Information Also Included:

- Loss of Signal/Rain Fade.....page 14
Installation with Long Cable Run.....page 15
Troubleshooting Check List for Initial Installation...page 15

Optional Accessories (not included)

Typical installation kits (sold separately) include:

- Mast base mounting hardware
- RG-6 coaxial cable(s) with F connectors
- Grounding hardware, grounding wire, wire clips, etc.
- Monopole (mast stabilizing arm)
- S Tube Mount (used in place of standard EZALIGN™ mast when mounting on the corner of a house)

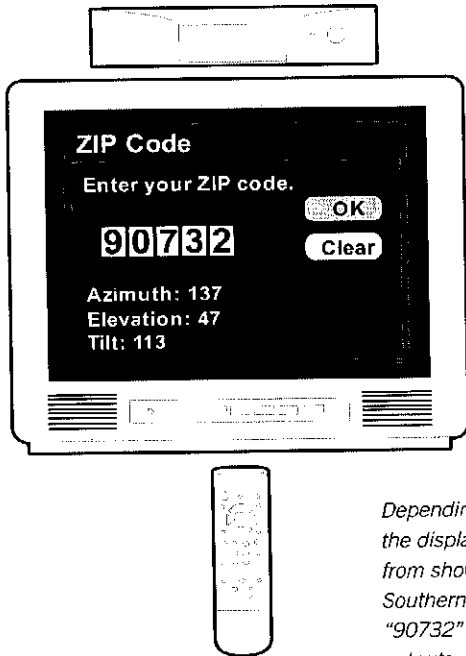

Depending on the receiver model, the display may look different from shown. In this example, a Southern California ZIP code "90732" is entered and receiver outputs:

- Azimuth: 137°
- Elevation: 47°
- Tilt: 113°

STEP 1

Determining Coordinates for Aiming Antenna

The coordinates (Azimuth, Elevation and Tilt numbers) are based on the local ZIP code and can be determined easily by using the receiver. You will need these numbers for the site survey and antenna adjustments.

NOTE: The antenna does not need to be installed for this step.

Connect the receiver to the TV.

Consulting the receiver manual, connect the receiver's video or Channel 3/4 outputs to the corresponding TV input. Turn on the TV and the receiver.

Set the antenna type

Navigate to the antenna installation screen menu. Select installation as a "5 LNB Multi-Sat".

Find the coordinates

Navigate to the antenna-pointing menu screen. Enter the local ZIP code, then write the numbers in the space provided below.

Azimuth
(horizontal, side-side)

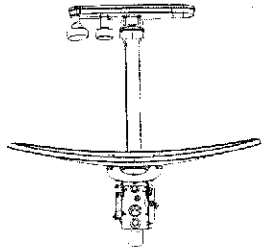

Azimuth

Elevation
(vertical, up/down)

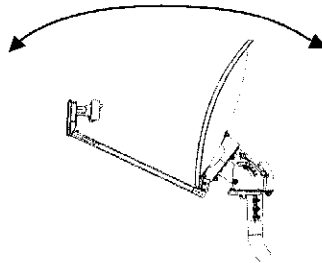

Elevation

Tilt
(dish reflector rotation)

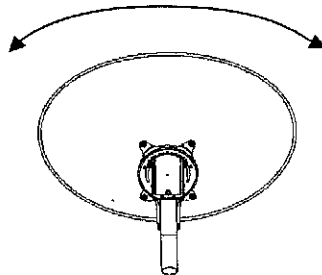

Tilt

STEP 2 Finding Suitable Antenna Site

A suitable antenna site requires an unobstructed view of the southern sky, a stable antenna mounting surface, a distance of 100-ft or less for RG-6 cable from the antenna to the receiver, and grounding nearby.

NOTE: It is important to estimate the cable length at this point.

The DIRECTV satellites are located in the southern sky above the Equator. The location for the antenna must have elevation-angle clearance (above the horizon) and a 20° span clearance (from 99° to 119°) for an unobstructed view to all five satellite locations. Northern border states have elevation readings toward 30° and southern border states have elevation readings toward 60°.

NOTE: If you are replacing an existing 18" or Triple head dish you will need to install a new mast and hardware to support this larger dish. One or two Monopoles are recommended for most *Slimline* dish antenna installations, with the exception of a corner S Tube mount.

If you are on the West Coast, the satellites will be to the south-southeast.

If you are on the East Coast, the satellites will be to the southwest.

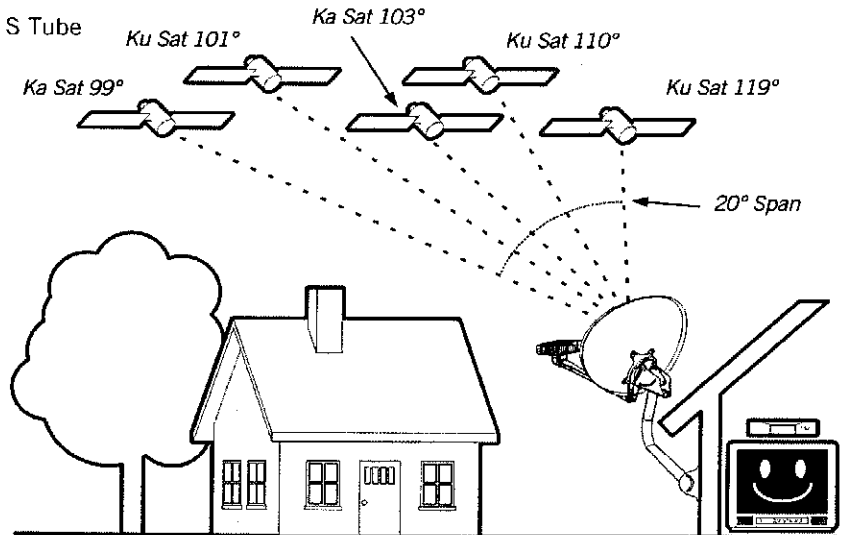
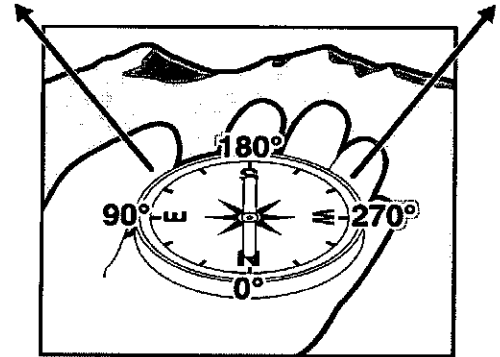

No trees, leaves, buildings can be in the line-of-sight between antenna and satellites.

Due to the many configurations possible, mast-mounting hardware is not included. Be sure you have the necessary mounting hardware before you begin. Optional Monopoles are available and recommended for all installations. Below are potential mounting sites.

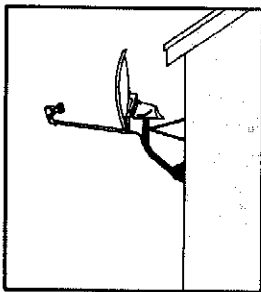

Stucco Exterior Wall
(With two optional Monopoles)

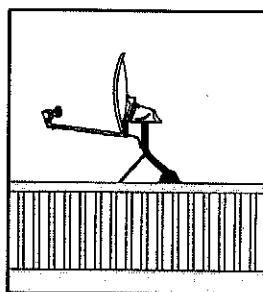

Wooden Rail
(With one optional Monopole)

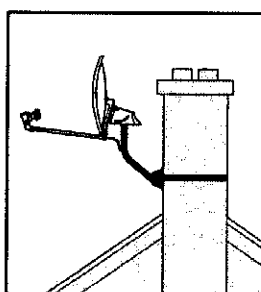

Chimney

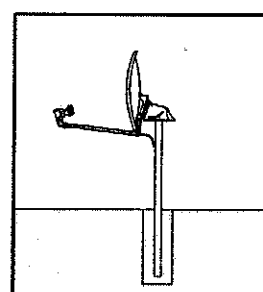

Ground

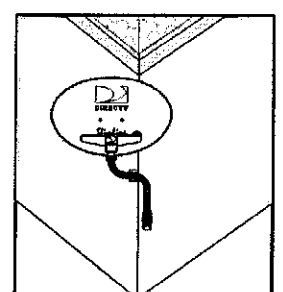

Corner of a House,
S Tube Mount

STEP 3 Installing EZALIGN™ Mast

View of bubble level on top of mast

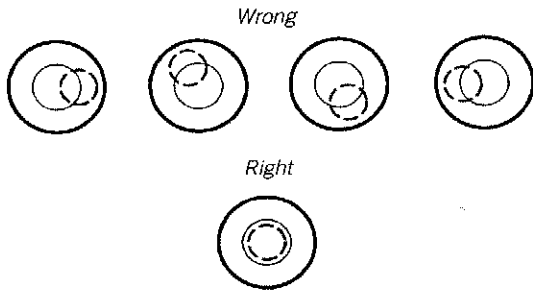

Side view of bubble level in the mast

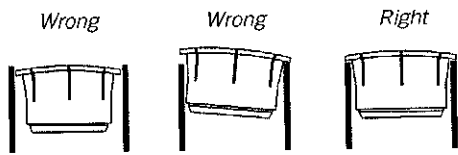

Looking down into mast

The patented mast has two slots at the bottom that allow it to move up and down and side to side. This aids in centering the bubble level even when the mast base is mounted on an uneven surface.

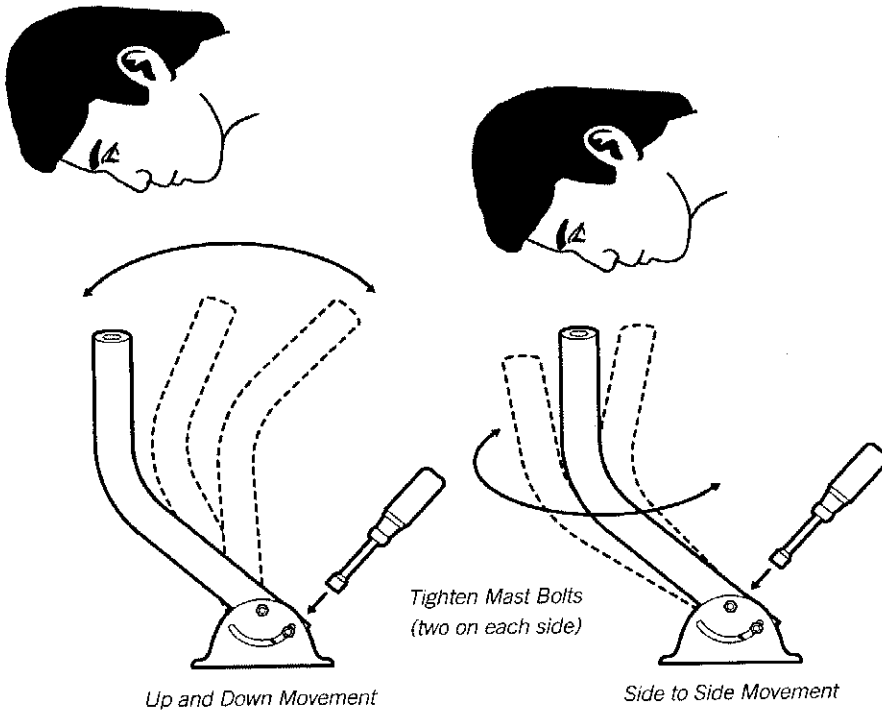

Now, you are ready to install the antenna mast at the location you have chosen in Step 2 and align it to be plumb (perfectly straight up). Plumbing the mast is critical for the Multi-Satellite Dish antenna to receive optimal signals. Failure to align it properly will result in difficulty acquiring signals as well as a greater tendency for signal outages in adverse weather.

NOTE: One or two Monopoles are recommended for most *Slimline* dish antenna installations, with the exception of a corner S Tube mount.

Mount the base securely

The mast base must be sturdy so antenna does not shift under various weather conditions and its own weight. Mounting is preferable on wood or masonry. Unsuitable sites may be handrails, aluminum or vinyl siding, composite paneling, and fiber/particle/strand boards.

Caution! When installing mast base, avoid placing finger between mast bottom and base to prevent being pinched or cut.

Align the mast

- The EZALIGN Mast pivots up and down, and side to side. A bubble level is located on the top of the mast to assist in alignment.
- Loosen the four mast bolts slightly. Then move the mast up/down or twist side-to-side until the bubble in the bubble level is centered as shown at left.

Caution! If the mast is mounted in a location where it is difficult or dangerous to view the bubble level, use a small mirror or plumbing level instead.

DO NOT reach out and risk falling from roof or other high place.

Tighten mast bolts

When mast is straight up (plumbed), and while still keeping hold of the mast, tighten the four bolts with a 1/2" nut driver with your other hand. Make sure bolts are secure. You may want to tighten further with an adjustable wrench.

STEP 4 Assembling/Adjusting Antenna on Ground

Note: The AZ/EL back assembly is separately packed and does not come with this dish antenna. This is because DIRECTV has more than one approved AZ/EL back assemblies for the *Slimline* dish antenna. At the time of this writing, there are two approved AZ/EL back assemblies and are shown on the right. Assembly of either AZ/EL back assembly to our dish antenna back frame is similar.

On even ground, attach dish to the LNB Arm/AZ/EL Back Assembly as shown. Leave off the LNB until the antenna is mounted on the mast and you've routed cable through the LNB Arm.

- Attach feed arm to back frame using Feed Arm Hardware; four 5/16" X 5/8" Hex Head Bolts, 5/16" Flat Washers & 5/16" Lock Washers.
- Attach AZ/EL back assembly to back frame using three sets of the Dish Mounting Hardware; 5/16" X 5/8" Carriage Head Bolts & 5/16" Serrated Flange Nuts. **Note: These 3 Carriage Head Bolts & Nuts are packaged separately with the AZ/EL Mount**
- Attach dish to back frame using four sets of Dish Mounting Hardware; 5/16" X 5/8" Round Flat Head Bolts & 5/16" Serrated Flange Nuts.

Set the Tilt

- At the back of the antenna assembly, loosen the Tilt nuts and set the Tilt adjustment according to the coordinate number you obtained in Step 1.
- Loosely tighten the Tilt nuts as the tilt will be fine tuned in Step 9.

Set Elevation Adjustment

- At the side of the antenna assembly, loosen the two Elevation nuts (one on each side) and preliminarily set the Elevation. In this example we show adjustment per the coordinate number obtained in Step 1.
- Tighten the left side Elevation nut only (as viewed from the rear of dish). You will fine

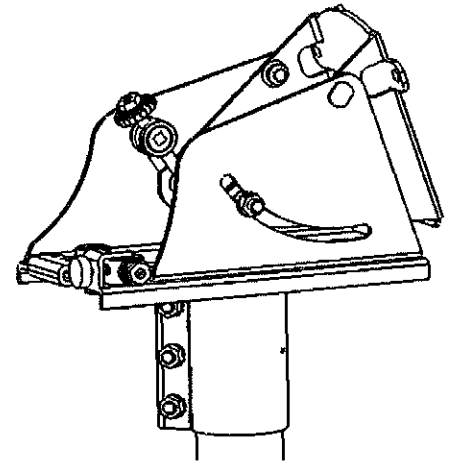

Dish Assembly with AZ/EL Back Assembly Type 1,
CalAmp# 151561

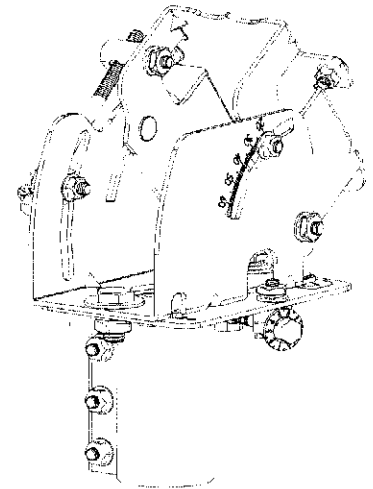

Dish Assembly with AZ/EL Back Assembly Type 2,
WNC# BAU

STEP 5 Attaching Antenna to Mast

- Slide the AZ/EL mast clamp onto the top of the mast until it bottoms out inside the AZ/EL mast clamp base. If necessary, slightly loosen the mast clamp bolts so the AZ/EL mast clamp will slide fully onto the mast.
- Tighten the mast clamp bolts just enough so the antenna has only side-to-side movement (rotational swing around the mast) for later Azimuth alignment in Step 9.

STEP 6 Routing RG-6 Cable(s)

You will route RG-6 cables from the receiver to the cable grounding block, then from the grounding block to the LNB. Before starting, inspect the inside of each cable connector for foreign materials and/or short. Make sure that the copper center conductor is straight and centered in the connector.

Run cable from receiver

Verify that there are no wires or pipes blocking the location where you want to feed the coaxial cables into the home. Drill a 1/2" inch hole for each cable. Connect cable to the "Sat In" jack on the back of the receiver. To prevent short, leave receiver unplugged until Step 9.

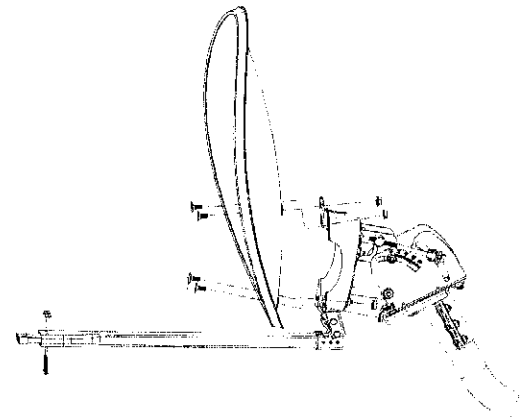

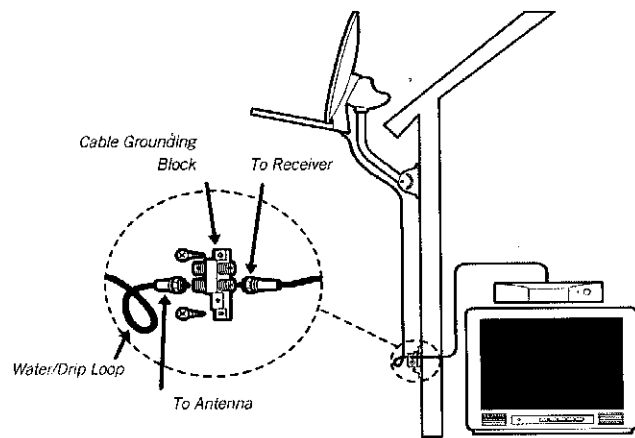

Dual grounding block, one receiver hook up shown

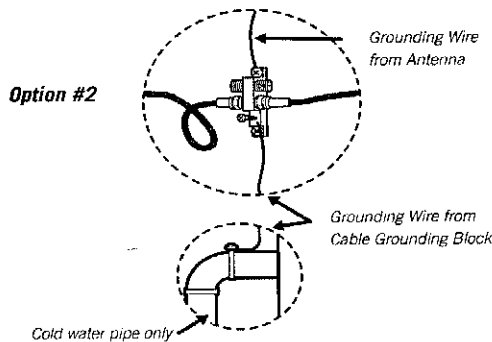
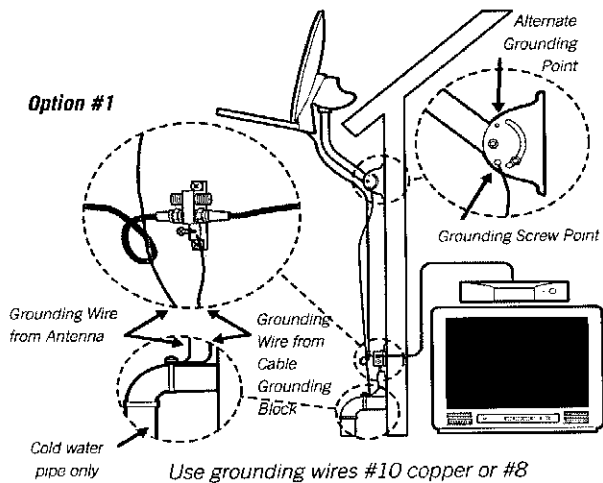

Slimline Ka/Ku LNB

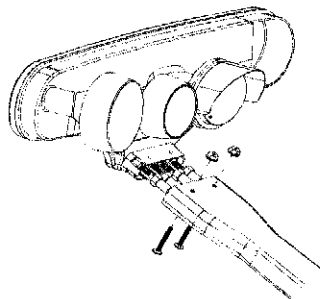

Hooking up cables to the LNB and attaching the LNB to Antenna — up to four cables can be connected this way.

Connect to grounding block

Mount the grounding block close to the point of cable entry into the house. Connect cable to grounding block as shown.

STEP 7 Grounding Cable to Antenna

Grounding the antenna and cable grounding block helps protect the satellite receiver system and other components from lightning damage.

- Ground wire can be attached anywhere on the metal part of the antenna, but there is a convenient grounding screw at one side of the mast base. *Installation should comply with local codes and the National Electric Code (NEC, Sections 250 and 810).*
- Grounding point can be an outside metal cold water pipe at point of entry (**no** gas or hot water pipes), 8-foot ground rod, grounded metallic service raceway, grounded electric service equip. enclosure, etc. **Option #1:** Both ground wires go to the same ground point. If the two grounding points are different, a #6 copper wire should be connected between them. **Option #2:** The dish antenna grounding wire goes to the grounding block first, then to the grounding point.

STEP 8 Attaching Integrated LNB to Antenna

It is recommended that the LNB is attached to the LNB Arm/Antenna AZ/EL Back Assembly after the antenna is mounted on the mast.

The LNB has four identical outputs. Each output supports one independently operating receiver. To simplify future installations of additional receivers or other components, it may be desirable to route more than one cable to the antenna at this point. However, only one cable is needed for antenna fine-tuning and alignment.

Attach all RG-6 cables to the LNB and assemble the LNB to the feed arm before attempting alignment. It is important to not remove the LNB from the dish after antenna alignment so make sure all needed RG-6 cables are attached at this point.

- Route all RG-6 cables through the LNB Arm and connect to the LNE outputs.
- Assemble the LNB to the feed tube as shown, using two 8-32 x 1 3/8" Hex Head Screws and 8-32 serrated nuts included with the LNB Mounting Hardware.
- Make sure all needed RG-6 cables are attached at this point. It is important to not remove the LNB from the dish after antenna alignment.

STEP 9 Aiming & Fine-tuning Antenna

SlimLine Ka/Ku Dish Antenna must be installed with greater precision and accuracy over previous Ku-only systems.

SlimLine Ka/Ku Dish Antenna is aligned to Ku satellites at 101° & 119°. Therefore a simple, external in-line Ku signal meter is all that is required. Use of a DIRECTV receiver as a signal meter for antenna alignment is not an acceptable method for peaking the antenna.

IMPORTANT NOTICE ON AZ/EL FINE-TUNING:

- Fine tuning involves finding the true beam peaks of the Ku and Ka signals.
- DIRECTV uses the Ku 101°/119° W beams for fine tuning, instead of a Ka signal, due to reasons of local Ka signal availability, Ka atmospheric noise, etc.
- Because the top of the Ku beam is relatively flat, missing the true beam peak at Ku by a small amount can cause a significant degradation at Ka.

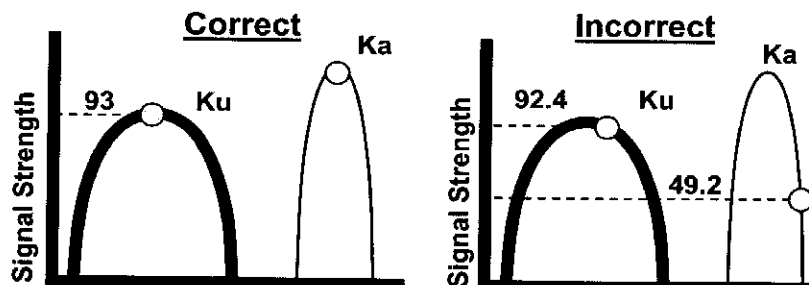

FINDING TRUE BEAM PEAK USING THE DITHER APPROACH:

Dither is a method used to find the true beam peak. This applies to both styles of back assemblies:

- Find two equal signal points on the two slopes.
- If there are X number of fine-tuning turns between the two signal points, then the half-way point is the true beam peak.

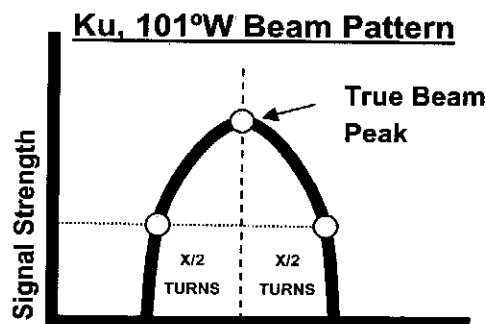

Step 9A should be used for the CalAmp AZ/EL back assembly Model 151561.

Step 9B should be used for the WNC AZ/EL back assembly Model BAU.

STEP 9A Coarse align Azimuth and Elevation for CalAmp Model 151561

- Make sure the mast is perfectly plumbed, from Step 3.
- Set the in-line signal meter for 101° RHCP reception (13 volts with no 22 KHz tone). Alternate method is to select 101° satellite and an odd numbered transponder on the customer's receiver to power the LNB.
- Slowly rotate the antenna around the mast in the Azimuth direction until a peak is obtained, and then lock down the mast clamp bolts.
- Using a 1/2" Nut Driver, adjust the fine elevation screw for maximum signal level. If the fine elevation screw runs out of range or is not centered in its range of movement, loosen the elevation lock down screw and move the coarse elevation slightly to keep the bolt centered.

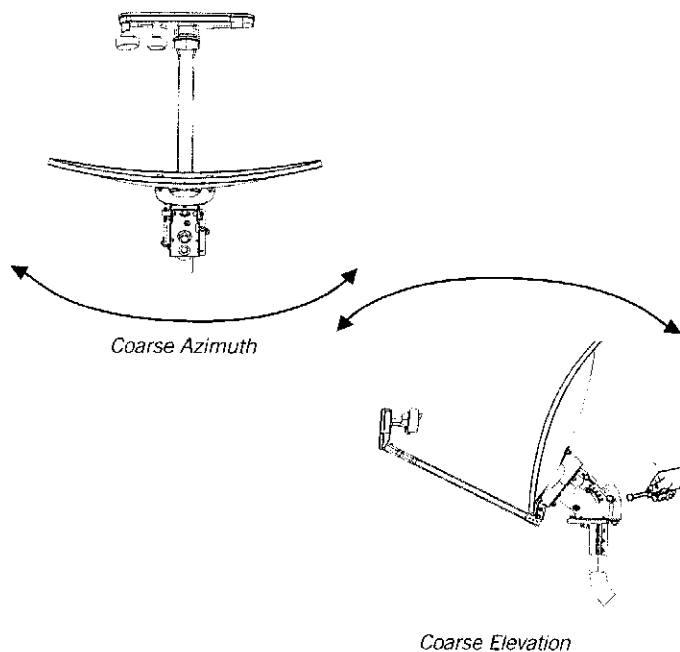

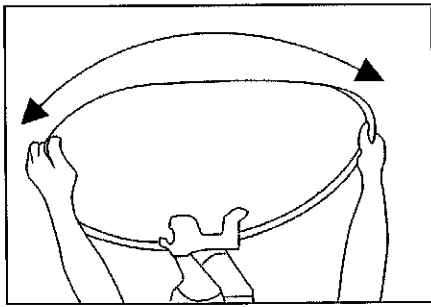

With the Tilt lock down nuts slightly loose, grasp the outer edges of the dish to peak the tilt

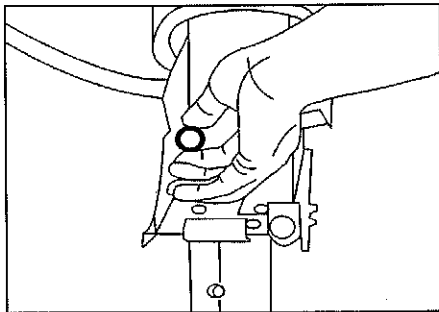

Start Elevation Fine-tune by grasping the black Elevation readout dial and rotate until "0" is lined up with the indicator

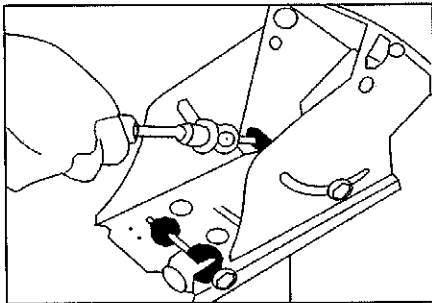

Use a 1/2" Nut Driver to turn the Elevation Fine-tune screw. Accurately count turns during this step

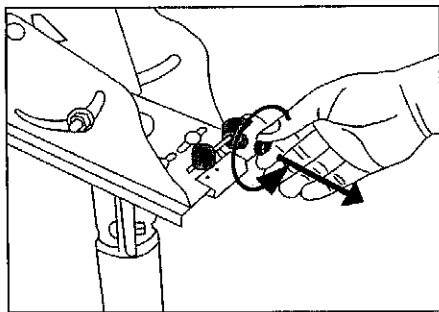

Unscrew the Dither Lock Pin to enable Dither side-to-side movement

- Record the coarse alignment signal level at this point for comparison during a later step.

Signal Level _____

After coarse alignment, verify reception of a DIRECTV 101° satellite with a meter capable of positively identifying a satellite or use the customer receiver. Broadband signal meters may respond to satellites other than DIRECTV so this is an important step.

Fine-tuning the Tilt

- Set the in-line signal meter for 119° RHCP reception (13 volts with 22 KHz tone). An alternative method is to select 119° satellite and an odd numbered transponder on the customer receiver to power the LNB.

Warning: Fine-tuning Elevation (EL) and Azimuth (AZ) mechanisms will be damaged if the dish is aligned when the EL and AZ lockdown bolts are tightened. This is because the fine tuning mechanisms have no place to go except buckling. See below for CalAmp back assembly Model 151561.

IMPORTANT!

Loosen the three Lockdown Nuts (1) **BEFORE** turning the Elevation (2) and Azimuth (3) Fine-tune screws. Failure to do so may cause damage to the assembly. Make sure to tighten the Lockdown Nuts (1) **AFTER** the respective Fine-tune adjustments have been completed.

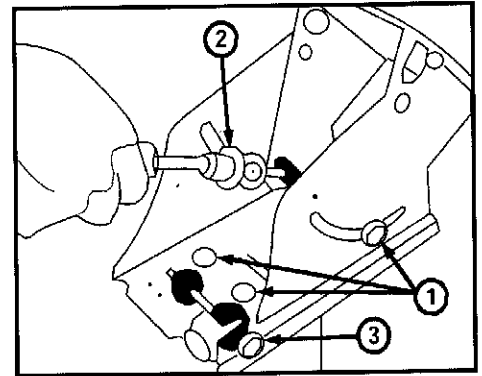

- Slightly loosen the Tilt lockdown nuts first. Slowly rotate the dish (left and right) around the tilt axis in order to peak the 119° signal, then carefully tighten the Tilt lockdown nuts.

Fine-tuning the Elevation

- Set the in-line signal meter for 101° RHCP reception (13 volts with no 22 KHz tone). An alternative method is to select 101° satellite and an odd numbered transponder on the customer's receiver to power the LNB.
- With the Elevation having been coarse peaked previously, now grasp the plastic Elevation readout dial and rotate until 0 is lined up with the indicator. Be careful not to turn the Elevation fine adjustment bolt during this step.
- Using a 1/2" Nut Driver, rotate the Elevation Fine-tune screw exactly **2 full turns COUNTER CLOCKWISE** and record the level from the signal meter. (This level will be lower than that obtained in the Elevation coarse peak.)

Signal Level _____

- While counting the exact number of turns as well as fractions of a turn, rotate the Elevation fine tune screw **CLOCKWISE** (through the peak) and continue until an identical signal level is reached as recorded above (This is typically between 5 and 7 turns). The numbers will be incrementing in reverse order, thus the number displayed on the dial will not correspond directly to the total distance turned. Example: If you stop on 6, you actually moved 4 Increments clockwise past zero, not 6.

Record # of turns _____

- Divide the number of turns just recorded by 2. Then rotate the Elevation Fine-tune screw **COUNTER CLOCKWISE** by this amount. It is convenient to re-zero (set the dial back to 0) at the beginning of this step to make turns counting easier.
- Tighten the Elevation lock down nut.

Fine-tuning the Azimuth

The Azimuth fine-tuning procedure uses identical signal readings either side of peak in order to arrive at precise alignment. Please follow the next few steps very carefully.

- Verify that the Azimuth lock down bolts are slightly loosened so as to allow free movement of the dither mechanism.
- Unscrew and pull out the dither lock pin and verify the dish will move slightly side to side without binding.
- Set the in-line signal meter for 101° RHCP reception (13 volts with no 22 KHz tone). An alternative method is to select 101° satellite and an odd numbered transponder on the customer's receiver to power the LNB.
- Move the dish fully to the **LEFT** against the dither stop and read the signal level. This level will be lower than that obtained and recorded during coarse Azimuth peak.
- Move the dish fully to the **RIGHT** against the opposite dither stop and compare the signal level to the previous reading.
- Turn the Azimuth fine adjustment screw to increase the lower of the two signal levels and repeat left/right dither process until **IDENTICAL SIGNAL LEVELS** are achieved for the **LEFT** and **RIGHT** stops. This may take several adjustments to achieve identical signal levels.

Verify satellite signals

Use the Guided Setup in the customer's receiver to verify reception on all available satellites. Consult the receiver manual for this step. Signal levels should be the same or higher than what was recorded at the end of coarse peaking.

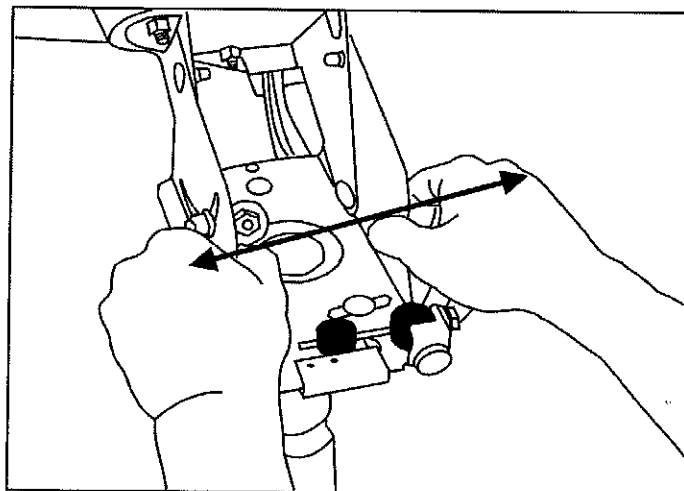

When moving the Dish to the Left and Right Dither stops, grasp the rear of the mount, not the Dish

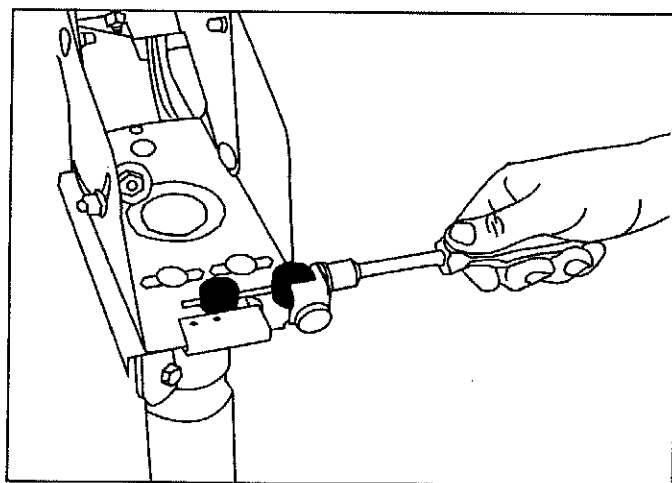

Use a 1/2" Nut Driver to adjust the Azimuth Fine-tune until the exact same signal level is reached at the Left and Right Dither stops

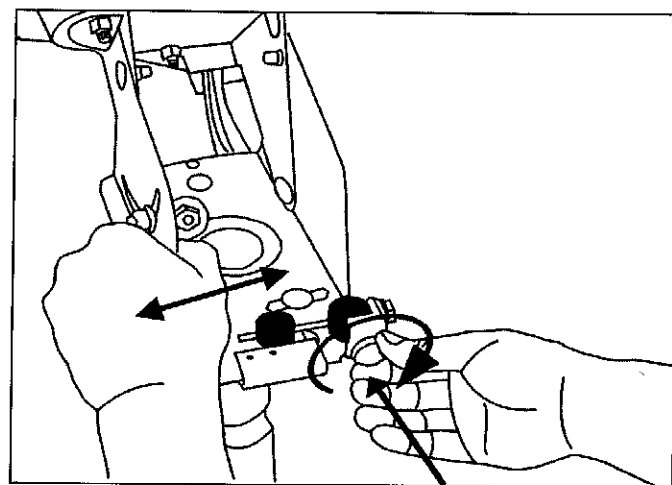

When replacing the Dither Pin, center the mount and rock side-to-side while rotating the Dither Pin Clockwise.

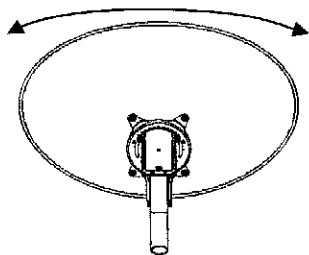
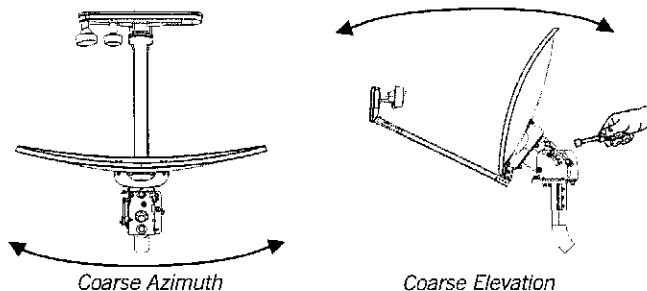
STEP 9B**Coarse align Azimuth and Elevation for WNC Model BAU**

With the Tilt lock down nuts slightly loose, grasp the outer edges of the dish to peak the tilt

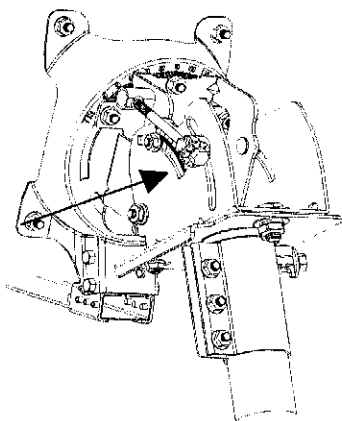

Start Elevation Fine-tune by grasping the black Elevation readout dial and rotate until "0" is lined up with the indicator

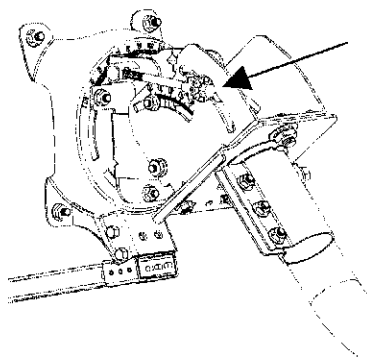

Use a 1/2" Nut Driver to turn the Elevation Fine-tune screw. Accurately count turns during this step

- Set the in-line signal meter for 101° RHCP reception (13 volts with no 22 KHz tone). Alternate method is to select 101° satellite and an odd numbered transponder on the customer's receiver to power the LNB.
- Slowly rotate the antenna around the mast in the Azimuth direction until a peak is obtained, and then lock down the mast clamp bolts.
- Using a 1/2" Nut Driver, adjust the fine elevation screw for maximum signal level. If the fine elevation screw runs out of range or is not centered in its range of movement, loosen the elevation lock down screw and move the coarse elevation slightly to keep the bolt centered.
- Record the coarse alignment signal level at this point for comparison during a later step.

Signal Level _____

After coarse alignment, verify reception of a DIRECTV 101° satellite with a meter capable of positively identifying a satellite or use the customer receiver. Broadband signal meters may respond to satellites other than DIRECTV so this is an important step.

Fine-tuning the Tilt

- Set the in-line signal meter for 119° RHCP reception (13 volts with 22 KHz tone). An alternative method is to select 119° satellite and an odd numbered transponder on the customer receiver to power the LNB.

Warning: Fine-tuning Elevation (EL) and Azimuth (AZ) mechanisms will be damaged if the dish is aligned when the EL and AZ lockdown bolts are tightened. This is because the fine tuning mechanisms have no place to go except buckling. See below for WNC back assembly Model BAU.

IMPORTANT!

Loosen the Lockdown Nuts (1) [Elevation Both Side] and (2) **BEFORE** turning the Elevation (3) and Azimuth (4) Fine-tune screws. Failure to do so may cause damage to the assembly. Make sure to tighten the Lockdown Nuts (1) [Elevation Both Side] and (2) **AFTER** the respective Fine-tune adjustments have been completed. Don't touch all black screws and nuts any time.

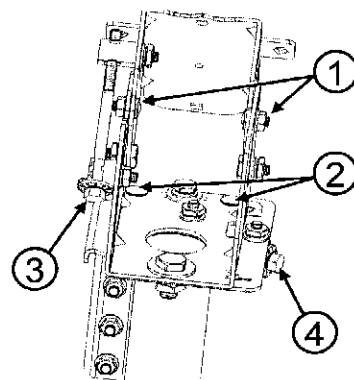

- Slightly loosen the Tilt lockdown nuts first. Slowly rotate the dish (left and right) around the tilt axis in order to peak the 119° signal, then carefully tighten the Tilt lockdown nuts.

Fine-tuning the Elevation

- Set the in-line signal meter for 101° RHCP reception (13 volts with no 22 KHz tone). An alternative method is to select 101° satellite and an odd numbered transponder on the customer's receiver to power the LNB.

- With the Elevation having been coarse peaked previously, now grasp the plastic Elevation readout dial and rotate until 0 is lined up with the indicator. Be careful not to turn the Elevation fine adjustment bolt during this step.
- Using a 1/2" Nut Driver, rotate the Elevation Fine-tune screw exactly **2 full turns COUNTER CLOCKWISE** and record the level from the signal meter. (This level will be lower than that obtained in the Elevation coarse peak.)

Signal Level _____

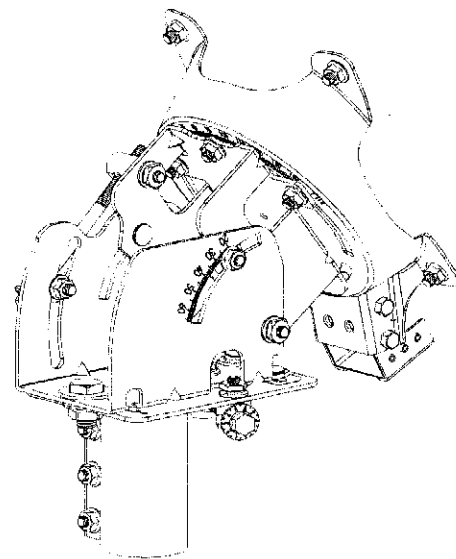

Use a 1/2" Nut Driver to adjust the Azimuth Fine-tune until the exact same signal level is reached at the Left and Right Dither stops

- While counting the exact number of turns as well as fractions of a turn, rotate the Elevation fine tune screw **CLOCKWISE** (through the peak) and continue until an identical signal level is reached as recorded above (This is typically about 4 turns). The numbers will be incrementing in reverse order, thus the number displayed on the dial will not correspond directly to the total distance turned. Example: If you stop on 6, you actually moved 4 Increments clockwise past zero, not 6.

Record # of turns _____

- Divide the number of turns just recorded by 2. Then rotate the Elevation Fine-tune screw **COUNTER CLOCKWISE** by this amount. It is convenient to re-zero (set the dial back to 0) at the beginning of this step to make turns counting easier.
- Tighten the Elevation lockdown nut.

Fine-tuning the Azimuth

- Verify that the Azimuth lockdown bolts are slightly loosened so as to allow free movement of the Azimuth fine-tune mechanism.
- Set the in-line signal meter for 101° RHCP reception (13 volts with no 22 KHz tone).
- With the Azimuth having been coarse peaked previously, now grasp the plastic Azimuth readout dial and rotate until 0 (zero) is lined up with the indicator (be careful not to turn the Azimuth fine adjustment bolt during this step).
- Using a 1/2" Nut Driver, rotate the Azimuth fine tune screw exactly **3 turns COUNTER CLOCKWISE** and record the level from the signal meter. (This level will be lower than that obtained in the Azimuth coarse peak.)
- Note this signal level.

Signal Level _____

- While counting the exact number of turns as well as fractions of a turn, rotate the Azimuth fine tune screw **CLOCKWISE** (through the Peak) and continue until an identical signal level is reached as that recorded from the last step (roughly 5-7 turns). The numbers will be incrementing in reverse order, thus the number displayed on the dial will not correspond directly to the total distance turned.
- EXAMPLE: If you stop on 6 you actually moved 4 increments clockwise past zero, not 6.
- Record the number of turns.

Record # of turns _____

- Divide the number of turns just recorded by 2. Then rotate the Azimuth fine-tune screw Counter Clockwise by this amount.
- Tighten the Azimuth lockdown nut.

Verify satellite signals

Use the Guided Setup in the customer's receiver to verify reception on all available satellites. Consult the receiver manual for this step. Signal levels should be the same or higher than what was recorded at the end of coarse peaking.

Loss of Signal/Rain Fade

- The satellite signal may be lost temporarily due to unusually heavy rainfall. An optimally aligned antenna, along with the shortest possible cable run, minimizes the chances of “rain fade”.
- Make sure the antenna is mounted securely to prevent it from being blown out of alignment in a heavy wind.
- Heavy snow accumulation on the LNB and the antenna may reduce the satellite signal strength; snow should be swept away as soon as possible.
- Tree foliage growth into antenna’s line-of-sight to the satellite may result in gradual loss of picture.

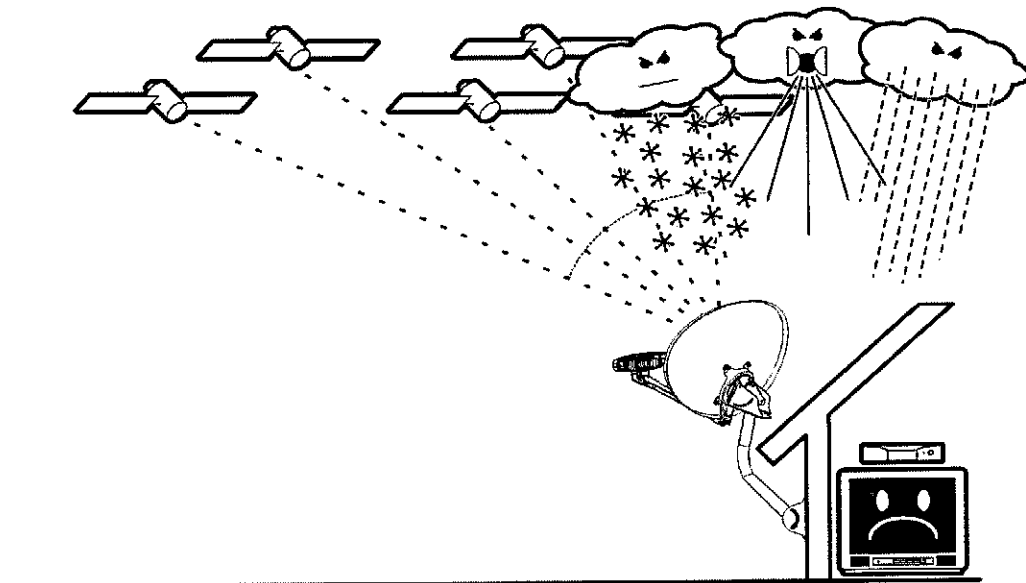

Installation with Long Cable Run

- For installations where the RG-6 cable runs from the receiver(s) to the LNB far exceeds 100 feet (150 feet or more), as encountered in a commercial or multi-dwelling building, you need to use an AC power booster module to bias the LNB.
- You will also need an additional RF signal amplifier to compensate the signal amplitude loss. Otherwise, your antenna and receiver may not work properly and be subject to frequent outages in adverse weather. Contact a professional concerning such installations.

Troubleshooting Check List for Initial Installation

- Make sure all cable connections are correct and each connection is seated/tightened properly.
- Inspect the inside of each cable connector for dirt or possible connector to case/shield short.
- Verify the Azimuth, Elevation and Tilt angles for your location by ZIP code.
- Make sure the Tilt and Elevation pointers are aligned correctly to the scales. Do not use washer or bolt as reference.
- Make sure the bubble level frame inside the mast is seated properly, then check the mast alignment again. The mast not being plumb/up straight is a major cause of alignment difficulty.
- Remove existing TV-specific components, such as TV splitter, etc; reduce the installation to the basic connections called out in this guide. Such components may not work with the satellite signal and they may be in the wall where you can't see them. When in doubt, run RG-6 cable directly to the receiver.
- Make sure there are no obstructions (trees, buildings, windows, corner or overhang of your roof, your body or hands) — the signal does not pass through leaves, branches, glass, etc. Also, keep in mind the 22° span clearance to receive all three satellite locations. This required clearance may also mean you'll need to consider a new location when replacing an old 18" dish with this new *SlimLine* Multi-Satellite Dish Antenna.
- Make sure the Access Card for your receiver is fully inserted into the Access Card slot and oriented correctly.
- The Integrated LNB depends on the receiver to supply power; the longer the cable length to the LNB, the greater the DC voltage drop. The receiver depends on the antenna to supply signal; the longer the cable length, the greater the signal amplitude attenuation. Therefore, RG-6 cable length much longer than 100 feet (from each receiver to the antenna) should be avoided.
- RG-6 cable with solid copper center conductor is highly recommended because it has much lower DC voltage drop compared to RG-6 cable with a copper-coated, steel center conductor.
- Standard RG-59 cable causes too much DC drop and signal drop; it can not be used to pass the satellite signal. RG-6 coaxial cable must be used.
- Some after-market, off-the-shelf add-on components may not be as advertised. They might not work or could cause additional DC drops and signal amplitude attenuation. Remove such components, go back to the basic connections called out in this manual and re-verify.
- Any additional in-line components must be approved for use with this *SlimLine* which has a specified frequency range of 250 MHz to 2150 MHz.
- Make sure the satellite cable is connected to the "Sat In" jack, not the "Antenna In" jack. The "Antenna In" jack at the back of the receiver is for off-air antenna input or cable TV input.
- If all are done correctly but the signal is still not found, change the Elevation adjustment of the antenna slightly ($\pm 2^\circ$, then $\pm 4^\circ$ from the called-for setting) and repeat the procedure.