

TA-36

**UHF/VHF/FM
Distribution
Amplifier**



**Installation
And
Operation
Manual**



Safeguards

Read This First

Important Information

Product Inspection

Inspect the equipment for shipping damage. Should any damage be discovered, immediately file a claim with the carrier.

Important Safety Instructions

To insure proper installation and operation, take a moment to read this guide before proceeding with the installation. If you have any questions or comments about the **TA-12** amplifier, please contact the **PICO MACOM** Service Center at the phone numbers on the bottom of the page.

The lightning flash with arrowhead symbol, within an equilateral triangle, is intended to alert the user to the presence of uninsulated “dangerous voltage” within the product’s enclosure that may be of sufficient magnitude to constitute a risk of electric shock to persons.

The exclamation point within an equilateral triangle is intended to alert the user to the pres-



ence of important operating and maintenance (servicing) instructions in the literature accompanying the appliance.

WARNING: TO REDUCE THE RISK OF FIRE OR ELECTRIC SHOCK, DO NOT EXPOSE THIS APPLIANCE TO RAIN OR MOISTURE. DO NOT OPEN THE CABINET. REFER SERVICING TO QUALIFIED PERSONNEL ONLY.

CAUTION: TO PREVENT ELECTRIC SHOCK DO NOT USE THIS (POLARIZED) PLUG WITH AN EXTENSION CORD RECEPTACLE OR OTHER OUTLET UNLESS THE BLADES CAN BE FULLY INSERTED TO BLADE EXPOSURE.

ATTENCION: POUR PREVENIR LES CHOCS ELECTRIQUES, NE PAS UTILISER CETTE FICHE POLARISEE AVEC UN PROLONGATEUR, UNE PRISE DE COURANT OU UNE AUTRE SORTIE DE COURANT, SAUF SI LES LAMES PEUVENT ETRE INSEREES A FOND SANS EN LAISSER AUCUNE PARTIE A DECOUVERT.

1. **Read Instructions** - All safety and operating instructions should be read before the appliance is operated.
2. **Retain Instructions** - The safety and operating instructions should be retained for future reference.
3. **Heed Warnings** - All warnings on the appliance should be adhered to.
4. **Follow Instructions** - All operating and use instructions should be followed.
5. **Cleaning** - Unplug this appliance from the wall outlet before cleaning. Use a damp cloth for cleaning. Do not use liquid cleaners or aerosol cleansers.
6. **Do Not Use Attachments** - Not recommended by the manufacturer or they may cause hazards.

Safeguards

Important Information

7. Water and Moisture - Do not use this product near water - for example, near a bathtub, washbowl, kitchen sink, laundry tub, in a wet basement, or near a swimming pool - and the like.

8. Accessories - Do not place this product on an unstable cart, stand, tripod, bracket, or table. The product may fall, causing serious injury to a child or adult, and serious damage to the appliance.

9. Ventilation - This video product should never be placed near or over a radiator or heat register. This video product should not be placed in a built-in installation such as a bookcase or rack unless proper ventilation is provided or the manufacturer's instructions have been adhered to. Any slots or opening in the cabinet are provided for ventilation. To ensure reliable operation of the video product and to protect it from overheating, these openings must not be blocked or covered. The openings should never be blocked by placing the product on a bed, sofa, rug, or other similar surface.

10. Grounding or Polarization - This video product is equipped with a polarized alternating - current line plug (a plug having one blade wider than the other). This plug will fit into the power socket only one way. This is a safety feature. If you are unable to insert the plug full into the outlet, try reversing the plug. If the plug should still fail to fit, contact your electrician to replace your obsolete outlet. Do not defeat the safety purpose of the polarized plug.

11. Power Sources - This product should be operated only from the type of power source indicated on the marking label. If you are not sure of the type of power supplied to your home, consult your appliance dealer or local power company.

12. Power-cord Protection - Power-supply cords should be routed so they are not likely to be walked on or pinched by items placed upon or against them. Pay particular attention to cords and plugs, convenience receptacles, and the point where they exit from the appliance.

13. Lightning - For added protection for this product during a lightning storm, or when it is left unattended and unused for long periods of time, unplug it from the wall outlet.

14. Power Lines - An outside antenna system should not be located in the vicinity of overhead power lines, other electric light or power circuits, where it can fall into such power lines or circuits. When installing an outside antenna system, extreme care should be taken to keep from touching such power lines or circuits as contact with them may be fatal.

15. Overloading - Do not overload wall outlets and extension cords as this can result in risk of fire or electric shock.

16. Object and Liquid Entry - Never push objects of any kind into this product through openings as they may touch dangerous voltage points or short-out parts that could result in a fire or electric shock. Never spill liquid of any kind on the product.

17. Servicing - Do not attempt to service this product yourself as opening or removing covers may expose you to dangerous voltage or other hazards. Refer all servicing to qualified service personnel.

18. Damage Requiring Service - Unplug this product from the wall outlet and refer servicing to qualified service personnel under the following conditions:

- a. When the power-supply cord or plug is damaged.
- b. If liquid has been spilled, or objects have fallen into the product.
- c. If the product has been exposed to rain or water.

Safeguards

Important Information

d. If the product does not operate normally by following the operating instruction. Adjust only those controls that are covered by the operating instructions. An improper adjustment may result in damage and will often require extensive work by a qualified technician to restore the product to its normal operation.

e. If the product has been dropped or the cabinet has been damaged.

19. Replacement Parts - When replacement parts are required, be sure the service technician has used replacement parts specified by the manufacturer or have the same characteristics as the original parts. Unauthorized substitutes may result in fire, electric shock or other hazards.

20. Safety Check - Upon completion of any service or repairs to this product, ask the service technician to perform safety checks to determine that the product is in proper operating condition.

21. Outdoor Antenna Grounding - Before attempting to install this product, be sure the antenna or cable system is grounded so as to provide some protection against voltage surges and built-up static charges.

a. Use No.10 AWG (5.3mm) copper, No.8 AWG (8.4mm) aluminum, No.7 AWG (10mm) copper-clad steel or bronze wire or larger, as ground wire.

b. Secure antenna lead-in and ground wires to house with stand-off insulators spaced from 4 feet (1.22m) to 6 feet (1.83m) apart.

c. Mount antenna discharge unit as close as possible to where lead-in enters house.

d. A driven rod may be used as the grounding electrode where other types of electrode systems do not exist. Refer to the National Electrical Code, ANSI/NFPA 70-1984 for information.

e. Use jumper wire not smaller than No.6 AWG (13.3mm) copper or equivalent, when a separate antenna grounding electrode is used.

f. When the product exhibits a distinct change in performance - this indicates a need for service.

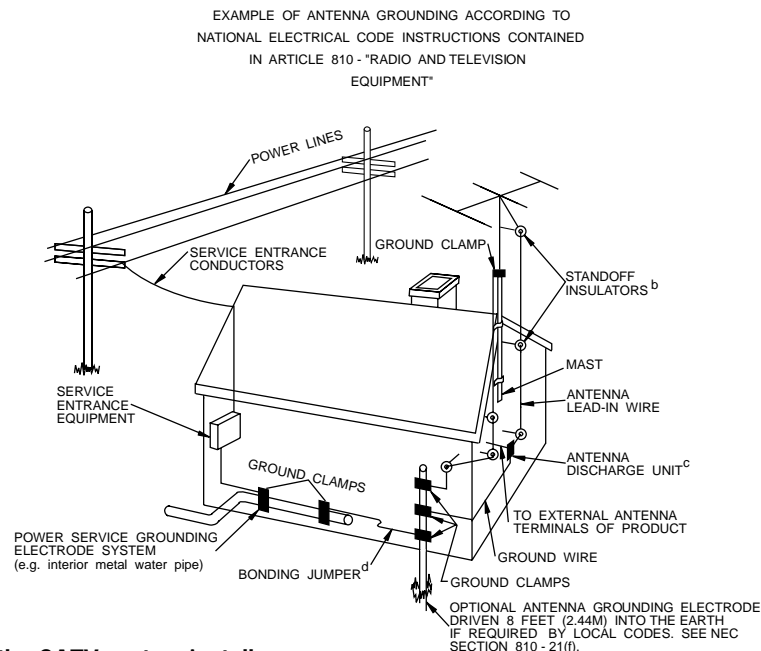

"Note to the CATV system installer:

This reminder is provided to call the CATV's system installer's attention to Article 820-40 of the NEC that provides guidelines for proper grounding and, in particular, specifies that the cable ground shall be connected to the grounding system of the building, as close to the point of cable entry as practical."

Specifications

Features

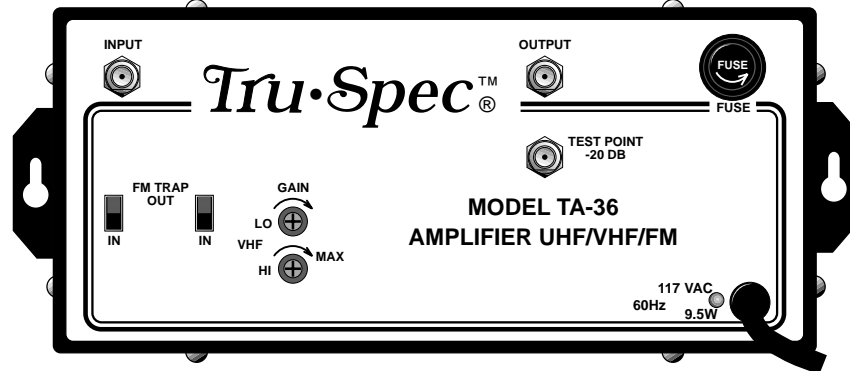

Features

- Two switchable FM traps
- Separate gain controls
- Low noise
- -20 dB monitor output
- Excellent for medium size MATV applications
- Low noise
- 50 dB output capability

Specifications

Bandwidth:

VHF Low band	54 to 108 MHz
VHF High band	174 to 216 MHz
UHF band	470 to 812 MHz

FM Traps: -20 dB @ 88 to 96 MHz, -20 dB @ 95 to 108 MHz
(see plot page 6)

Gain:

VHF	31 dB
UHF	36 dB

Gain Control Range: 15 dB

Noise Figure:

VHF	6 dB
UHF	7 dB

Channels:

	Max. Input	Max. Output
7 channels VHF	20 dBmV	52 dBmV
4 channels UHF	20 dBmV	56 dBmV
12 channels VHF	11 dBmV	43 dBmV
7 UHF	11 dBmV	45 dBmV

Power Requirements: 117Vac, 60Hz, 9.5W

Installation

Hook-Up

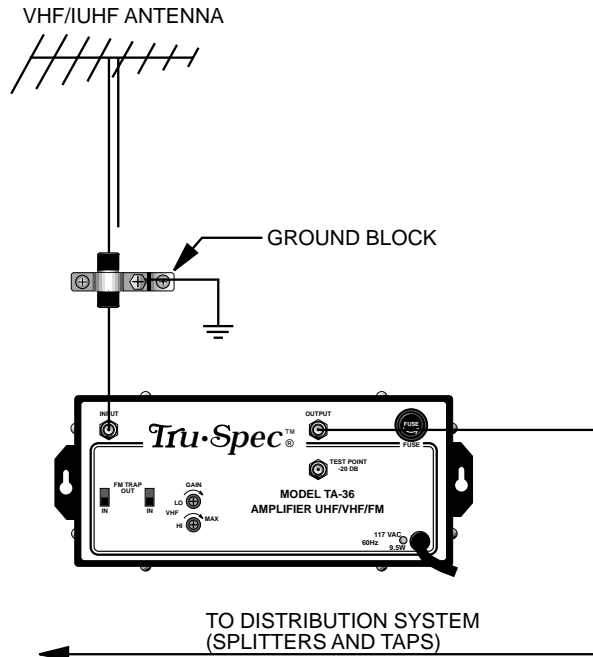

CAUTION: DO NOT EXCEED RECOMMENDED INPUT POWER RATING. SEE PAGE 4

Gain/Frequency Response

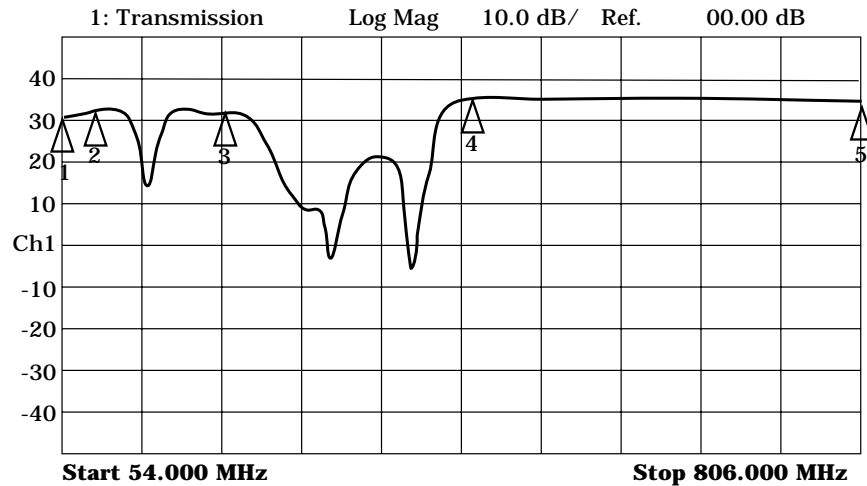

1: Mkr (MHz)	dB (TYP.)
1: 54.00	31.09
2: 88.00	32.27
3: 216.00	31.34
4: 470.00	36.32
5: 806.00	36.11

Performance

FM Trap Frequency Response

FM Trap -88 to 96 MHz

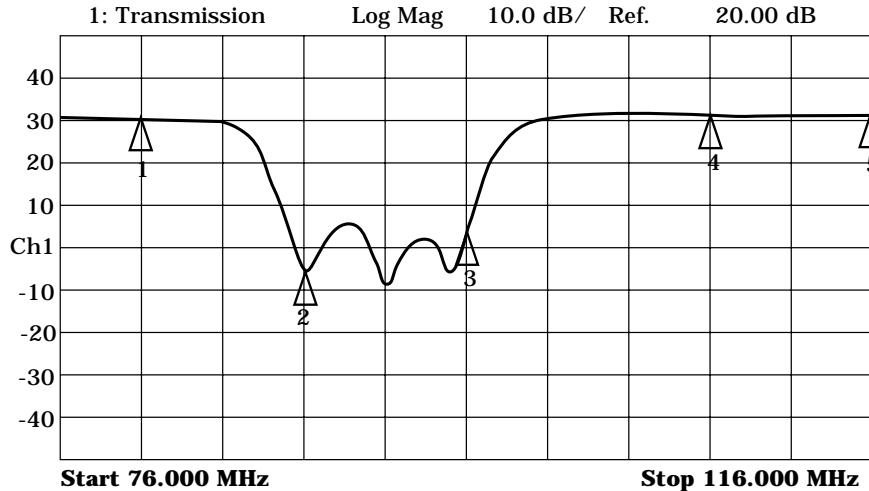

1: Mkr (MHz)	dB (TYP.)
1: 80.00	30.48
2: 88.00	-7.27
3: 96.00	-5.84
4: 108.00	31.76
5: 120.00	31.11

FM Trap - 95 to 108 MHz

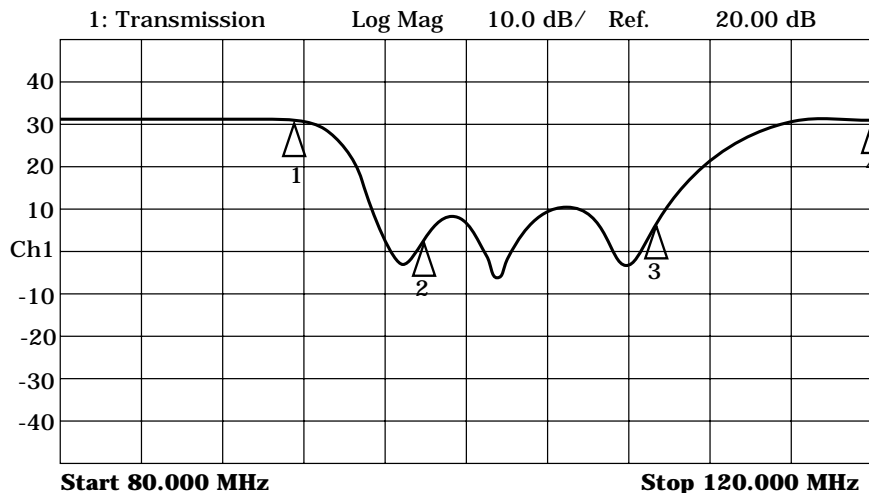

1: Mkr (MHz)	dB (TYP.)	2: Mkr (MHz)	dB (TYP.)
1: 88.00	30.38		
2: 95.00	2.06		
3: 108.00	6.54		
4: 120.00	30.15		

Warranty

Two Year Warranty*

Pico Macom, Inc. warrants to the original purchaser this product shall be free of defects in material and craftsmanship with only the limitations or exclusions set out below.

During the warranty period Pico Macom Inc. or an authorized Pico Macom service facility will provide free of charge, the parts and labor necessary to correct defects in material and workmanship.

WARRANTY DURATION

This warranty shall terminate two years from the original date of purchase of the product or at a time the product is:

1. Misused or damaged due to neglect or improper installation
2. Modified
3. Repaired by someone other than the warrantor
4. Sold by the original purchaser

STATEMENT OF REMEDY

To obtain warranty service, contact the salesperson where the product was obtained. You will be issued a Return Authorization (RA) number which will be used to track your product.

Be prepared to provide:

1. The model number of the product
2. The date of purchase
3. A specific identification of the problem

Deliver the products to Pico Macom Inc. or ship the products in the original packing material at the address at the bottom of the page. Include satisfactory evidence of the date of purchase.

Products will not be accepted by Pico Macom Inc. without the RA number clearly indicated on the shipping label.

The foregoing constitutes the Pico Macom, Inc. entire obligation with respect to this product and the original purchaser and any user or owner *shall have no outer remedy and no claim for incidental or consequential damages. Some states do not allow limitations on how long an implied warranty lasts or do not allow exclusions or limitation of incidental or consequential damages, so the above limitation and exclusion may or may not apply to you.*

This warranty gives you specific legal rights, and you also have rights which vary from state to state (U.S.A.).

* One year warranty if sold outside the United States.

Service Information

Schematic

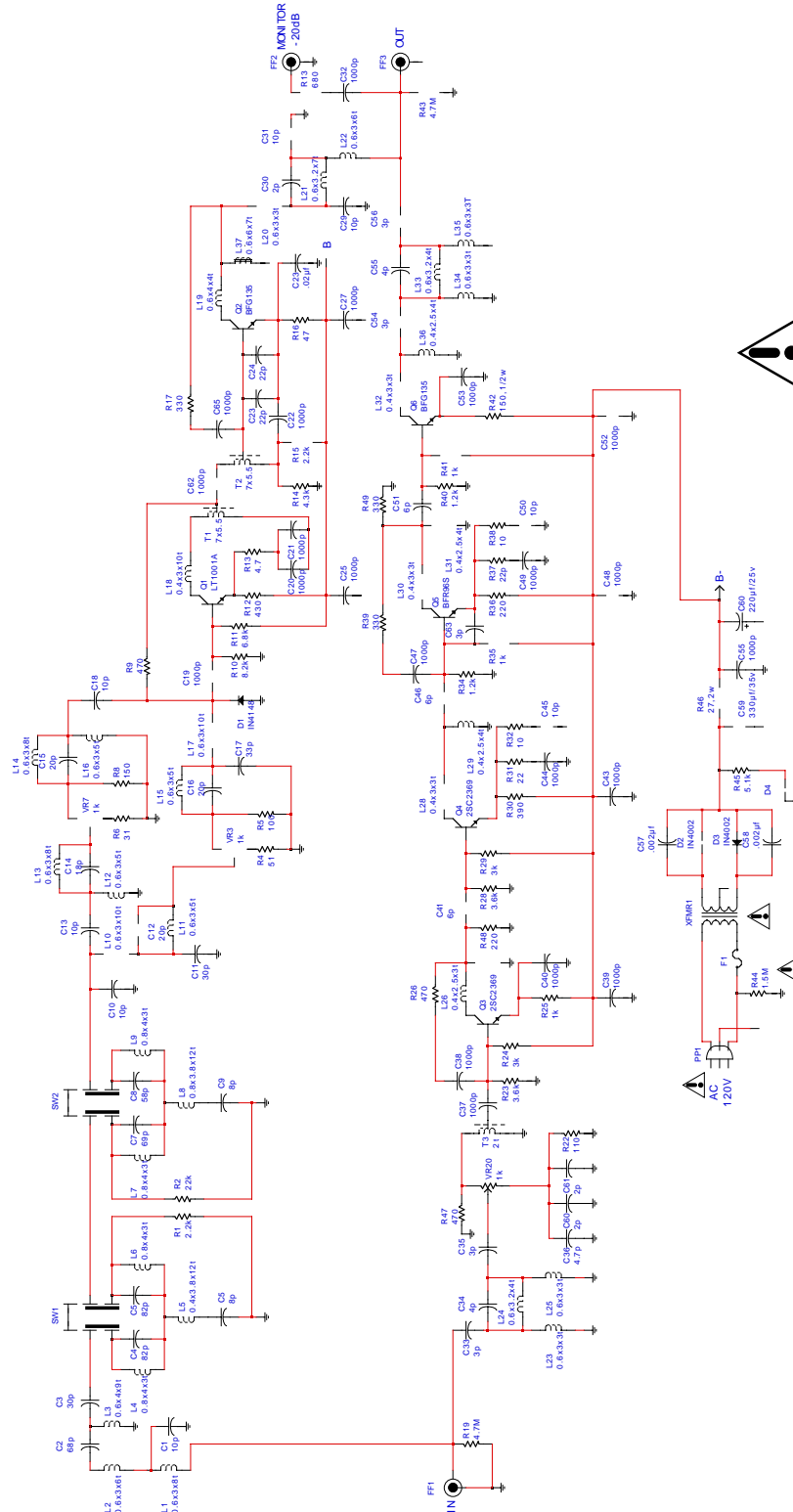

Caution:

1. Disconnect power before servicing.
2. The components identified by  on the schematic diagram are considered critical with respect to the risk of fire and electric shock associated with the product. Replace these components with the parts recommended by the manufacturer only.
3. Make leakage-current (0.5 mA max.) or resistance measurements (10 M ohm min.) to determine that exposed parts are acceptably insulated from the supply circuit before returning the appliance to the customer.

THIS DOCUMENT AND THE INFORMATION ENCLOSED HEREIN IS PROPRIETARY TO PICO MACOM INC. AND UNLESS SPECIFIED UNDER A WRITTEN AGREEMENT, MAY NEITHER BE REPRODUCED OR COPIED IN WHOLE OR IN PART OR DISCLOSED TO OTHERS, NOR EMPLOYED FOR DESIGN PROCUREMENT, OR MANUFACTURING PURPOSES WITHOUT THE WRITTEN PERMISSION OF PICO MACOM INC.

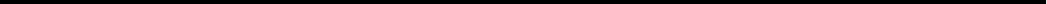

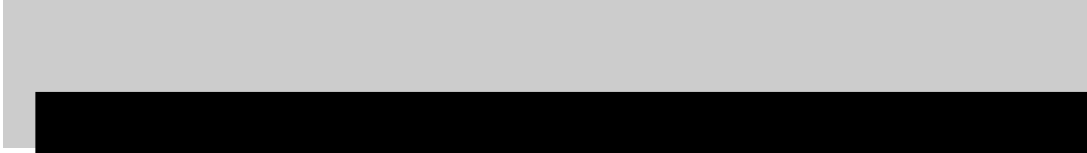

*Tru·Spec*TM®

PICO MACOM INC, U.S.A.